

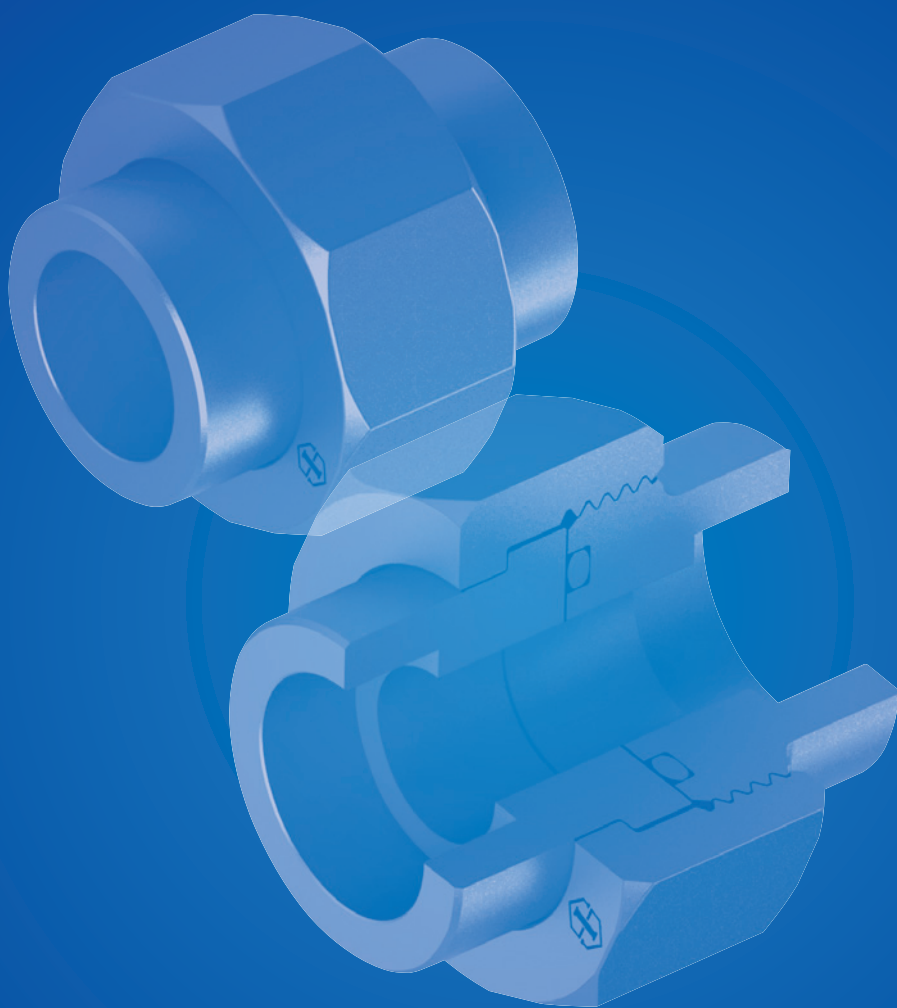

IHARA











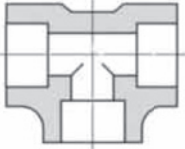

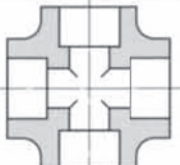
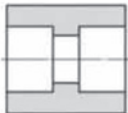
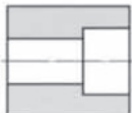
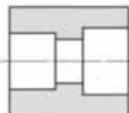
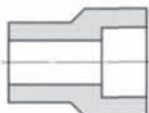
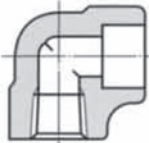
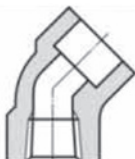
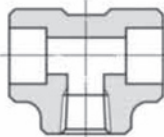
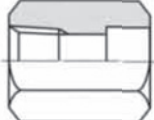
高圧管継手

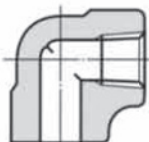
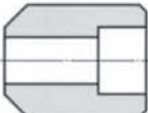
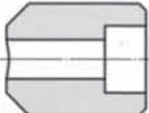
Fittings for High Pressure Application

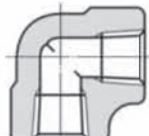

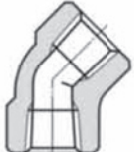
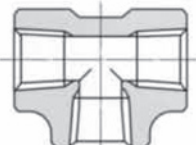

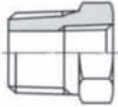

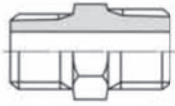
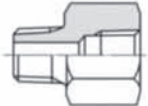
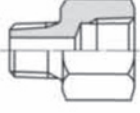
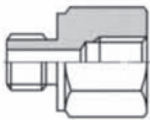
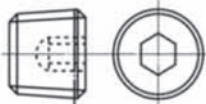
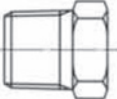
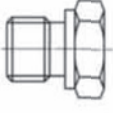

イハラサイエンス株式会社
IHARA SCIENCE CORPORATION

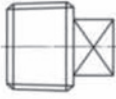
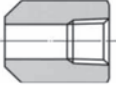
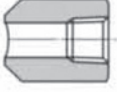
製品インデックス / VISUAL INDEX

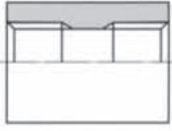
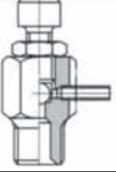
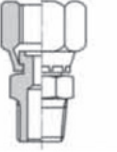
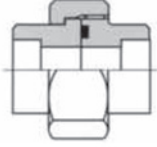
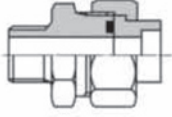
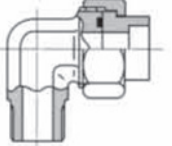
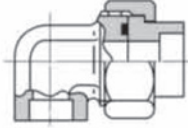
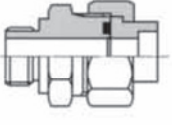
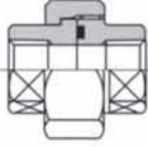
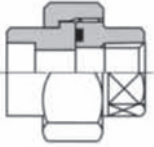
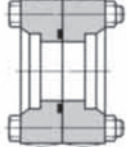
90°エルボ WLA 90°Elbow WLA 12 	ティー WTA Tee WTA 12 	45°エルボ WLB 45°Elbow WLB 13 	クロス WXA Cross WXA 13 
カップリング WFC Coupling WFC 14 	ハーフカップリング WHC Half Coupling WHC 14 	レジュース WRC Reducer WRC 15 	レジュースインサート WRM Reducing Insert WRM 16 
特殊90°エルボ SLD Special 90°Elbow SLD 17 	特殊45°エルボ SLE Special 45°Elbow SLE 17 	特殊ティー STD Special Tee STD 17 	特殊カップリング SFD Special Coupling SFD 18 
シリンダ用エルボ WLF Cylinder Elbow WLF 18 	シリンダ用エルボ SLF Cylinder Elbow SLF 18 	ボスA形 WBA Boss Type A WBA 19 	ボスR形 WBR Boss Type R WBR 19 
キャップ WCA Cap WCA 20 	90°エルボ SLA 90°Elbow SLA 21 	メスオスエルボ SLC Street Elbow SLC 21 	45°エルボ SLB 45°Elbow SLB 22 
ティー STA Tee STA 22 	カップリング SFC Coupling SFC 23 	レジュース SRC Reducer SRC 23 	プッシング SBU Bushing SBU 24 
ニップル SNP Nipple SNP 24 	径違いニップル SRN Reducing Nipple SRN 25 	メスオスソケットA形 SSS Street Socket Type A SSS 25 	メスオスソケットB形 SSS Street Socket Type B SSS 26 
メスオスソケットC形 SSF Street Socket Type C SSF 26 	六角穴付プラグ SPA Hollow hex Plug SPA 26 	六角プラグ(テーパねじ) SPB Hex Plug SPB 27 	六角プラグ(平行ねじ) SPE Hex Plug SPE 27 

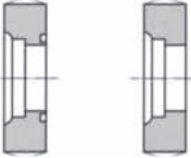
INDEX

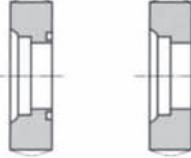
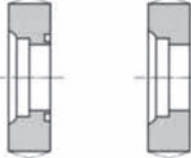
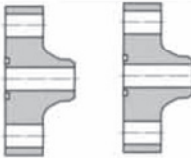
四角頭付プラグ SPC Square Head Plug SPC 27 	ボスA形 SBA Boss Type A SBA 28 	ボスR形 SBR Boss Type R SBR 28 	キャップ SCA Cap SCA 29 
丸ソケット SMC Socket SMC 29 	エア抜きバルブ SAP Air Bleeding Valve SAP 30 	圧力計用アダプタ SGA Adapter for Pressure Gauge SGA 30 	ユニオンA形 WUA Union Type A WUA 31 
ユニオンB形 WUB Union Type B WUB 32 	ユニオンC形 WUC Union Type C WUC 32 	ユニオンD形 WUD Union Type D WUD 33 	ユニオンH形 WUH Union Type H WUH 33 
ユニオン SUA Union SUA 34 	ユニオンF形 WUF Union Type F WUF 34 	組フランジ FA-A Flange Assembly FA-A 35 	フランジ FA-HA・FA-HB Flange FA-HA・FA-HB 36 
フランジ FA-SA・FA-SB Flange FA-SA・FA-SB 37 	フランジ FA-LA Flange FA-LA 38 	フランジ FA-YA・FA-YB Flange FA-YA・FA-YB 39 	フランジ FA-ZA・FA-ZB Flange FA-ZA・FA-ZB 40 
フランジ FA-WA・FA-WB Flange FA-WA・FA-WB 41 			

ごあいさつ／INTRODUCTION

当社は、日本における高圧継手のトップメーカーとして半世紀におよぶ豊富な経験と実績をもとに油圧関連産業はもとより、原子力をはじめとしたパワープラント、石油、LNG、化学、製鉄プラント等、国内及び海外のあらゆる産業分野で高いシェアとご好評をいただいております。

Ihara Science Corporation is the leading manufacturer of high pressure fittings in Japan with more than 70 years of experience in development, design and production of high pressure fittings backed by track records not only in the hydraulic related industries but also in power generation including nuclear power plants, LNG and chemical plants as well as in steel mills where these fittings have been enjoying a very high share of the market. Users both domestic and overseas have high appraisal for the performance and quality of Ihara's high pressure fittings.

特徴／FEATURES

(1) 品種が豊富に揃っています。

- 一般的に使用される継手については少量多品種品について即納体制を日指しております。
- 当カタログ外の製品につきましても配管上必要と考えられる製品はほとんど設計系列化されておりますので御問合せ下さい。
- あらゆる規格、材質、形状の設計、製作に対応しております。
JIS、ANSI、DIN、ISO等

(1) A Wide Range of Fittings

- We are striving to be able to achieve prompt delivery for high mix, small lot requirements.
- The design series also include fittings that may not be listed in this catalogue but mandatory required for the piping. Contact us with your any inquiries.
- We will be responding to any type of standards (which include JIS, ANSI, DIN, ISO, etc.), materials and configurations.

(2) SoftからHardまで配管上のあらゆるニーズにお応えできます。

- 仕様を提示していただければ各種のバックデータ(強度計算、応力解析、実験値等)に基づき最適の設計・製作まで行ないます。
- また、当社の岐阜IPEC事業部において配管設計、配管加工、現地工事まで一貫したサービスも提供できます。

(2) We respond to all type of piping needs from Software to Hardware

- Upon receiving some special specifications, we will develop, an optimum piping design and fabrication by utilizing the back-up data (strength calculation, stress analysis, empirical values, etc.) accumulated through past experience.
- Our IPEC Plant can provide a complete range of services from piping design and fabrication to field installation work.

資格・許認可・認定／QUALIFICATIONS, APPROVALS AND CERTIFICATIONS

●造船関係／Shipbuilding Societies

一般財団法人 日本海事協会／Nihon Kaiji Kyokai
American Bureau of Shipping
Det Norske Veritas

●原子力認定ならびにベンダー取得会社名／Nuclear Power Approval and Registered Vendor

三菱重工業株式会社／Mitsubishi Heavy Industries, Ltd.

株式会社日立製作所／Hitachi, Ltd.

東芝株式会社／Toshiba Corp.

富士電機株式会社／Fuji Electric Co., Ltd.

日揮株式会社／JGC Corporation

東洋エンジニアリング株式会社／Toyo Engineering Corp.

●プラント関係(ベンダー取得会社名)／General Contractors (Registered Vendor)

Shell Internationale Petroleum

Maatschappij B.V.

Aramco Overseas Co.,

Bechtel International

Fluor International, Inc.

The M.W. Kellogg Co.,Inc.

Exxon Mobil Corp.

●建設業許可／Construction Work Approval

建設大臣許可(一般-56)第6306号(管工事及び機械器具設置工事業)

Minister of Construction Approval (General-56) No.6306 (Piping work and equipment and machinery installation work)

JPF規格(日本金属継手協会規格)／

JPF STANDARDS (JAPAN PIPE FITTINGS ASSOCIATION STANDARDS)

昭和48年5月、高圧継手製造業者12社により日本高圧継手協会が設立され、協会加入各社による技術委員会により協会規格(FAS規格)が制定されました。

現在FAS規格は日本金属継手協会規格(JPF規格)として、JPF FAS101(特殊配管用鋼製差込み溶接式管継手)、JPF FAS102(高圧配管用鋼製ねじ込み式管継手)、JPF FAS103(油圧用35MPa(350kgf/cm²)突合せ溶接式管フランジ)、JPF FAS104(特殊配管用21MPa(210kgf/cm²)鋼製差込み溶接式、ねじ込み式ユニオン管継手)の4規格が制定されております。

Japan High Pressure Fitting Association was established in May, 1973 by 12 high pressure fitting manufacturers, and the Engineering Committee comprised by the member companies established the Japan High Pressure Fitting Association Standards (FAS Standards).

As a standard of the JAPAN PIPE Fittings Association.

The following 4 Standards have been established by the Engineering Committee:

JPF FAS 101: Socket-weld Type Steel Pipe Fittings for Special Service.

JPF FAS 102: Screwed Type Steel Pipe Fittings for High Pressure Service.

JPF FAS 103: 35 MPa (350 kgf/cm²) Butt Weld Type Pipe Flanges for Hydraulic Applications.

JPF FAS 104: 21 MPa (210 kgf/cm²) Steel Socket Weld Type and Threaded Type Union Pipe Fittings for Special Piping Applications.

1. 接続される鋼管の種類／TYPES OF STEEL PIPES to be connected

JIS G3454 (圧力配管用炭素鋼鋼管) STPG
JIS G3455 (高圧配管用炭素鋼鋼管) STS
JIS G3456 (高温配管用炭素鋼鋼管) STPT
JIS G3458 (配管用合金鋼鋼管) STPA
JIS G3459 (配管用ステンレス鋼鋼管) SUS-TP
JIS G3460 (低温配管用鋼管) STPL

JIS G3454 (Carbon Steel Pipes for General Service) STPG
JIS G3455 (Carbon Steel Pipes for High Pressure Service) STS
JIS G3456 (Carbon Steel Pipes for High Temperature Service) STPT
JIS G3458 (Alloy Steel Pipes) STPA
JIS G3459 (Stainless Steel Pipes) SUS-TP
JIS G3460 (Steel Pipes for Low Temperature Service) STPL

2. 関連規格／ASSOCIATED STANDARDS

- JIS B2316「配管用鋼製差込み溶接式管継手」
- JIS B2291「油圧用21MPa管フランジ」
- JIS F7806 船の280K及び350K油圧鋼管用差込み溶接式フランジ
- FAS 101 特殊配管用鋼製差込み溶接式管継手
- FAS 102 特殊配管用鋼製ねじ込み式管継手
- FAS 103 油圧用35MPa突合せ溶接式管フランジ
- FAS 104 21MPa鋼製差込み溶接式、ねじ込み式ユニオン管継手

- JIS B2316 Socket Weld Type Pipe Fittings for General Piping Applications
- JIS B2291 21 MPa Pipe Flanges for Hydraulic Applications
- JIS F7806 Socket Weld Type Flanges for 280K and 350K Hydraulic Steel Pipes for Ships
- FAS 101: Steel Socket Pipe Fitting Weld Type for Special Piping Applications
- FAS 102: Steel Threaded Pipe Fitting Weld Type for Special Piping Applications
- FAS 103: 35 MPa Butt Weld Type Pipe Flanges for Hydraulic Applications
- FAS 104: 21 MPa Steel Socket Weld Type and Threaded Type Union Pipe Fittings

3. 管継手の材料 / MATERIAL FOR FITTINGS

管継手の材料は、接続される鋼管に相当する鋼材として、表1によります。

The material of fittings shall coincide to the material of pipes to be connected as shown in Table 1.

表1 / Table 1

区分 Division	管継手の材料 Pipe Fittings Material	記号 Symbol	接続される鋼管 (参考) Connecting Steel Pipe (reference)	
炭素鋼 Carbon Steel	JIS G4051 S25C 又は or ASTM A105	PT410	STPG410, STPT410	圧力配管用 For general service
		————	STS370 STS410	高圧配管用 For high pressure service
合金鋼 Alloy Steel	ASTM A182 F11	PA23	STPA23	高温配管用 For high temperature service
	ASTM A182 F22	PA24	STPA24	
	ASTM A182 F5	PA25	STPA25	
ステンレス鋼 Stainless Steel	JIS G4303 SUS304	SUS304	SUS304TP	耐食 高温配管用 及び 低温配管用 For corrosion resistance, For high temperature piping and low temperature piping
	JIS G4303 SUS304L	SUS304L	SUS304LTP	
	JIS G4303 SUS316	SUS316	SUS316TP	
	JIS G4303 SUS316L	SUS316L	SUS316LTP	
	JIS G4303 SUS321	SUS321	SUS321TP	
	JIS G4308 SUS304	SUS304	SUS304TP	
	JIS G4308 SUS316	SUS316	SUS316TP	
	JIS G4318 SUS304	SUS304	SUS304TP	
	JIS G4318 SUS304L	SUS304L	SUS304LTP	
	JIS G4318 SUS316	SUS316	SUS316TP	
JIS G4318 SUS316L	SUS316L	SUS316LTP		
JIS G4318 SUS321	SUS321	SUS321TP		
低温用鋼 Steel for low temperature	ASTM A350 LF2	PL380	STPL380	低温配管用 For low temperature piping

注) 材料による標準製作品は炭素鋼、SUS304及びSUS316とします。

Note: Material of standard products shall be carbon steel, SUS304 and SUS316.

4. 耐圧性 / PRESSURE RESISTANCE

1. 差込み溶接形管継手は、ユニオン類及びフランジ類を除き、表1に指定した鋼管に関する日本工業規格 (JIS B2316の4項) に規定されている水圧試験圧力と同じ水圧に耐える事を保証します。
2. ねじ込み形管継手は、ユニオンを除き、31.4MPa (320kgf/cm²) の水圧を加え3分間保持しても破裂せず、また漏れないことを保証します。
3. ユニオン製、及びフランジ類については該当する各シートをご参照下さい。

1. Socket weld pipe fittings are warranted to withstand pressure equivalent to the hydrostatic test pressure specified in Japanese Industrial Standard (Chapter 4 of JIS B2316) for steel pipes indicated in Table 1, except for unions and flanges.
2. Threaded pipe fittings are warranted not to burst at hydrostatic pressure of 320 kgf/cm² and not to leak when retained for 3 minutes except for unions.
3. Refer to applicable pages in regards to unions and flanges.

5. 寸法及び寸法許容差 / DIMENSIONS AND DIMENSIONAL TOLERANCES

寸法はカタログの各シートにより、寸法許容差は表2によります。

The respective dimensions are noted in the applicable pages, and the applicable dimensional tolerances are as specified in Table 2 below.

表2 / Table 2

項目 Items	管継手の種類 Types of Pipe Fittings	径の呼び Nominal Diameter			
		1/8&1/4	3/8-3/4	1-2	2-1/2&3
		許容差 Tolerances			
差込み部の内径 (B) Socket bore (B)	すべての管継手 All pipe fittings	+0.3 0		+0.4 0	
穴径 (D) Bore diameter (D)		+0.4		+0.8	
差込み部の内径と穴径の偏心 Eccentricity of socket bore to bore diameter		±0.8			
差込み部の穴と管継手の穴の軸線との傾 Difference of socket bore axis to fitting bore axis		1.5/300以下 Less than 1.5/300			
中心から差込み部底面までの距離 (A) Dimension from center to socket bottom shoulder (A)	45°エルボ、90°エルボ、ティー、クロス 45° elbow, 90° elbow, Tee, Cross	±0.8	±1.5	±2	±2.5
差込み部底面両間の距離 (E) Dimension between socket bottom shoulders (E)	カップリング Coupling	±1.5	±3	±4	±5
差込み部底面から対面までの距離 (F) Dimension from socket bottom shoulder to opposite end (F)	ハーフカップリング Half Coupling	±0.8	±1.5	±2	±2.5
ねじ込み式管継手の外径 Outer diameter of threaded pipe fitting	45°エルボ、90°エルボ、ティー、クロス 45° elbow, 90° elbow, Tee, Cross	+1.6 -0.5	+2.0 -0.5	+2.0 -1.0	
	カップリング、ボス等 Coupling, Boss, etc	+1.2 -0.5		外径寸法の±1.8% ±1.8% of OD	
二面巾 Width across flats	すべての管継手 All pipe fittings	JIS B1002のB1の許容差2種による Tolerance of type 2, B1 of JIS B1002			
上記指定以外の寸法許容差 Dimensional tolerances for other than specified above					

6. ねじ / THREADS

管継手接続端部のねじは、JIS B0203(管用テーパねじ)、JIS B0202(管用平行ねじ)とします。
ユニオンナットのねじはJIS B0207(メートル細目ねじ)とします。

Threads of the pipe fitting connection ends shall be JIS B0203 (taper threads for pipes) and JIS B0202 (parallel thread for pipes).

Threads for union nuts shall be JIS B0207 (metric fine screw threads).

7. 製造方法 / MANUFACTURING PROCESS

管継手は3項に規定した材料から熱間又は冷間による塑性加工又は切削加工によって製造します。

Pipe fittings are produced by hot or cold plastic forming or machining material specified in Par. 3

表3 / Table 3

材 料 Material
JIS G4051 S25C ASTM A105
JIS G4303 SUS304 SUS304L SUS316 SUS316L
JIS G4318 SUS304 SUS304L SUS316 SUS316L

8. 検査 / INSPECTION

管継手は、JIS及び社内規格に基づき各工程ごとに検査を行い、安定した品質を確保しております。

Pipe fittings are inspected at each production stage in accordance with applicable JIS and in-house inspection standards to insure stable high quality.

1. 材料検査 / Material inspection

管継手の材料はJIS又はASTMに合致し、さらに社内基準に合格したものを使用します。
材料検査は次の項目について行います。

Material used for production of pipe fittings shall satisfy JIS or ASTM as well as in-house standards.
Following material inspection shall be performed:

- a) 形状・寸法検査 / Configuration and dimensional inspection
- b) 外観検査 / Visual inspection
- c) 材質確認検査 / Material confirmation inspection

その他必要に応じ次の各種特殊試験検査を行います。

In addition, following tests shall be performed as needed.

- 液体浸透探傷試験 / Liquid penetrant test
- 超音波探傷試験 / Ultrasonic test
- 引張試験 / Tensile test
- 衝撃試験 / Impact test
- 腐食試験 / Corrosion test

2. 中間検査 / Intermediate inspection

- a) 形状・寸法検査 / Configuration and dimensional inspection
- b) 外観検査 / Visual inspection

3. 受渡し検査 / Final inspection

- a) 形状・寸法検査 / Configuration and dimensional inspection
- b) 外観検査 / Visual inspection

11. その他 / OTHER TYPES

1. 径違いの継手はこのカタログに表示したものの以外は弊社の標準品ではありませんがご要望に応じますので、次の要領にてお引き合せ下さい。
1. Reduced type of fittings are limited to those listed in this catalogue, but other sizes can be made available upon request. When inquiring please observe the following rules:

a. 2個の口径をもつ場合 / Two different size bores

径の大きなものを①、小さなものを②という順序に呼ぶ。

Indicate the larger bore first ① followed by the smaller bore ②. Indicate in this numerical order.

b. 3個の口径をもつ場合 / Three different size bores

同一または平行な中心線上にある径の大きなものを①、小さなものを②、残りのものを③という順序に呼ぶ。

Indicate the larger bore of the two bores on the same center line first ① followed by the bore on the opposite end ②, and then the remaining bore ③. Indicate in the numerical order.

c. 4個の口径をもつ場合 / Four different bores

最大の径を①、これと同一または平行な中心線上にあるものを②、残り2個のうち径の大きなものを③、小さなものを④、という順に呼ぶ。

Indicate the largest bore first ① followed by the bore on the opposite end ②, and of the remaining two bores, indicate the larger bore ③ followed by the bore on the opposite end ④. Indicate in this numerical order.

例: 鋼製差込みティー: $3/4 \times 3/8 \times 1/2$ (sch.80)

注: 誤記防止のためできる限り下図のごとき略記号表示を用いて下さい。

Example: Steel socket weld reduction Tee: $3/4 \times 3/8 \times 1/2$ (sch.80)

Note: In order to preclude any misunderstanding, a simple sketch with size indications as shown below is recommended.

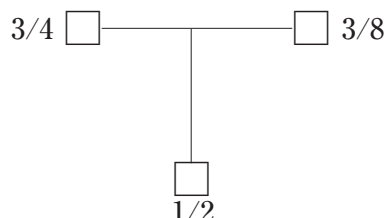

なお、上記何れの場合も、外径寸法は基本的に最大口径の同径の場合(本カタログ表示のもの)と同一になります。

When the outside bore diameter is the same diameter as the largest bore diameter in principle, the outside bore diameter shall be the same as indicated in this catalogue in all of the above cases.

2. 各シートの管継手には見越生産品と受注生産品とがありますので、念のため在庫をお問い合わせ下さい。
2. Pipe fittings listed in this catalogue include fittings available from stock shelves as well as fittings made upon orders, and it is therefore recommended to inquire first.
3. 品質、性能の改善、向上に伴い、本カタログと納入される製品とは多少異なる場合がありますのでご了承下さい。
3. The manufacturer is constantly implementing improvements on their products, and therefore reserves the right to modify the actual products to be delivered from the products of this catalogue.

WLA・WTA 差込み溶接形管継手 / Socket Weld Pipe Fittings

90° エルボ WLA / 90° Elbow WLA

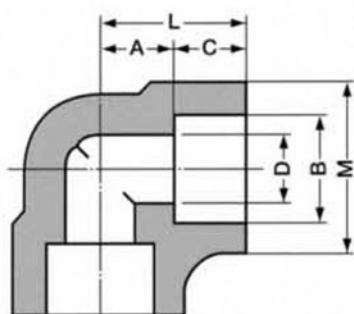

単位: mm / unit: mm

継手の呼び Part No.	呼び径 Nominal sizes	B	C	D	M	A	L	重量 (kg) Weight (kg)
Sch. 80								
WLA02-800F	1/4	14.3	10	9.4	23	11.1	21.1	0.097
WLA03-800F	3/8	17.8	11	12.7	28	13.5	24.5	0.13
WLA04-800F	1/2	22.2	13	16.1	34	15.9	28.9	0.24
WLA06-800F	3/4	27.7	14	21.4	39	19.1	33.1	0.33
WLA08-800F	1	34.5	16	27.2	47	22.2	38.2	0.52
WLA10-800F	1 1/4	43.2	18	35.5	57	27.0	45.0	0.82
WLA12-800F	1 1/2	49.1	19	41.2	64	31.8	50.8	1.05
WLA16-800F	2	61.1	22	52.7	77	38.1	60.1	1.81
WLA20-800F	2 1/2	77.1	26	65.9	96	41.3	67.3	3.17
WLA24-800F	3	90	29	78.1	110	57.2	86.2	5.14
Sch. 160								
WLA04-160F	1/2	22.2	14	12.3	39	19.1	33.1	0.46
WLA06-160F	3/4	27.7	16	16.2	47	22.2	38.2	0.90
WLA08-160F	1	34.5	18	21.2	57	27.0	45.0	1.22
WLA10-160F	1 1/4	43.2	19	29.9	64	31.8	50.8	1.65
WLA12-160F	1 1/2	49.1	22	34.4	77	38.1	60.1	2.95
WLA16-160F	2	61.1	26	43.1	96	41.3	67.3	5.53
WLA20-160F	2 1/2	77.1	29	57.3	110	57.2	86.2	7.93

注) 合金鋼、ステンレス鋼についてはC、L、M寸法が異なります。炭素鋼以外は寸法が異なるので、都度お問い合わせください。(Jシリーズになります。)
Note: Dimensions of C, L and M for alloy steel and stainless steel products deviate from the above dimensions. (contact us)

ティー WTA / Tee WTA

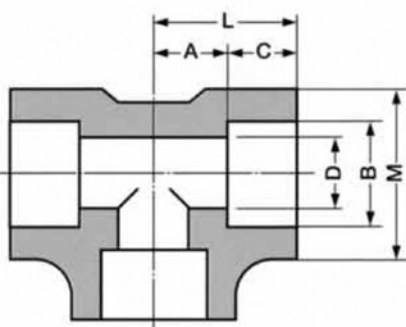

単位: mm / unit: mm

継手の呼び Part No.	呼び径 Nominal sizes	B	C	D	M	A	L	重量 (kg) Weight (kg)
Sch. 80								
WTA02-800F	1/4	14.3	10	9.4	23	11.1	21.1	0.11
WTA03-800F	3/8	17.8	11	12.7	28	13.5	24.5	0.19
WTA04-800F	1/2	22.2	13	16.1	34	15.9	28.9	0.30
WTA06-800F	3/4	27.7	14	21.4	39	19.1	33.1	0.39
WTA08-800F	1	34.5	16	27.2	47	22.2	38.2	0.61
WTA10-800F	1 1/4	43.2	18	35.5	57	27.0	45.0	0.93
WTA12-800F	1 1/2	49.1	19	41.2	64	31.8	50.8	1.18
WTA16-800F	2	61.1	22	52.7	77	38.1	60.1	2.06
WTA20-800F	2 1/2	77.1	26	65.9	96	41.3	67.3	3.51
WTA24-800F	3	90	29	78.1	110	57.2	86.2	5.97
Sch. 160								
WTA04-160F	1/2	22.2	14	12.3	39	19.1	33.1	0.64
WTA06-160F	3/4	27.7	16	16.2	47	22.2	38.2	0.99
WTA08-160F	1	34.5	18	21.2	57	27.0	45.0	1.53
WTA10-160F	1 1/4	43.2	19	29.9	64	31.8	50.8	1.80
WTA12-160F	1 1/2	49.1	22	34.4	77	38.1	60.1	3.70
WTA16-160F	2	61.1	26	43.1	96	41.3	67.3	5.90
WTA20-160F	2 1/2	77.1	29	57.3	110	57.2	86.2	8.98

注) 合金鋼、ステンレス鋼についてはC、L、M寸法が異なります。炭素鋼以外は寸法が異なるので、都度お問い合わせください。(Jシリーズになります。)
Note: Dimensions of C, L and M for alloy steel and stainless steel products deviate from the above dimensions. (contact us)

WLB・WXA 差込み溶接形管継手 / Socket Weld Pipe Fittings

45° エルボ WLB / 45° Elbow WLB

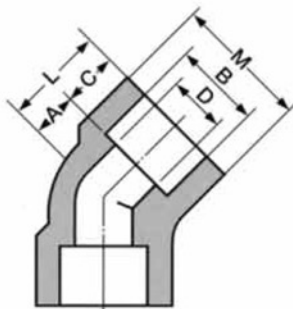

単位：mm/unit: mm

継手の呼び Part No.	呼び径 Nominal sizes	B	C	D	M	A	L	重量 (kg) Weight (kg)
Sch. 80								
WLB02-800F	1/4	14.3	10	9.4	23	7.9	17.9	0.087
WLB03-800F	3/8	17.8	11	12.7	28	7.9	18.9	0.11
WLB04-800F	1/2	22.2	13	16.1	34	11.1	24.1	0.20
WLB06-800F	3/4	27.7	14	21.4	39	12.7	26.7	0.29
WLB08-800F	1	34.5	16	27.2	47	14.3	30.3	0.45
WLB10-800F	1 1/4	43.2	18	35.5	57	17.5	35.5	0.69
WLB12-800F	1 1/2	49.1	19	41.2	64	20.6	39.6	0.92
WLB16-800F	2	61.1	22	52.7	77	25.4	47.4	1.48
WLB20-800F	2 1/2	77.1	26	65.9	96	28.6	54.6	2.38
WLB24-800F	3	90	29	78.1	110	31.8	60.8	3.04
Sch. 160								
WLB04-160F	1/2	22.2	14	12.3	39	12.7	26.7	0.41
WLB06-160F	3/4	27.7	16	16.2	47	14.3	30.3	0.66
WLB08-160F	1	34.5	18	21.2	57	17.5	35.5	1.04
WLB10-160F	1 1/4	43.2	19	29.9	64	20.6	39.6	1.28
WLB12-160F	1 1/2	49.1	22	34.4	77	25.4	47.4	2.24
WLB16-160F	2	61.1	26	43.1	96	28.6	54.6	4.04
WLB20-160F	2 1/2	77.1	29	57.3	110	31.8	60.8	5.92

注) 合金鋼、ステンレス鋼についてはC、L、M寸法が異なります。炭素鋼以外は寸法が異なるので、都度お問い合わせください。(Jシリーズになります。)
Note: Dimensions of C, L and M for alloy steel and stainless steel products deviate from the above dimensions. (contact us)

クロス WXA / Cross WXA

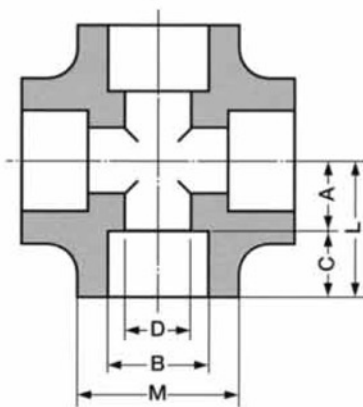

単位：mm/unit: mm

継手の呼び Part No.	呼び径 Nominal sizes	B	C	D	M	A	L	重量 (kg) Weight (kg)
Sch. 80								
WXA02-800J	1/4	14.3	12	9.4	23	11.1	23.1	0.16
WXA03-800J	3/8	17.8	13	12.7	27	13.5	26.5	0.25
WXA04-800J	1/2	22.2	13	16.1	33	15.9	28.9	0.42
WXA06-800J	3/4	27.7	16	21.4	39	19.1	35.1	0.60
Sch. 160								
WXA04-160J	1/2	22.2	15	12.3	39	19.1	34.1	0.78
WXA06-160J	3/4	27.7	16	16.2	47	22.2	38.2	1.20

注) 合金鋼、ステンレス鋼についてはC、L、M寸法が異なります。炭素鋼以外は寸法が異なるので、都度お問い合わせください。(Jシリーズになります。)
Note: Dimensions of C, L and M for alloy steel and stainless steel products deviate from the above dimensions. (contact us)

WFC・WHC

差込み溶接形管継手 / Socket Weld Pipe Fittings

カップリング WFC / Coupling WFC

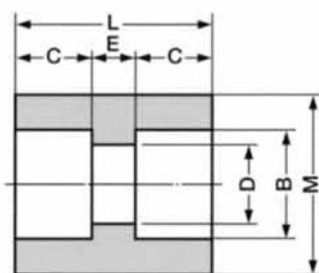

単位：mm/unit: mm

継手の呼び Part No.	呼び径 Nominal sizes	B	C	D	E	M	L	重量 (kg) Weight (kg)
Sch. 80								
WFC02-800F	1/4	14.3	10	9.4	6.4	22	26.4	0.049
WFC03-800F	3/8	17.8	10	12.7	6.4	26	26.4	0.064
WFC04-800F	1/2	22.2	10	16.1	9.5	32	29.5	0.11
WFC06-800F	3/4	27.7	13	21.4	9.5	38	35.5	0.17
WFC08-800F	1	34.5	13	27.2	12.7	46	38.7	0.25
WFC10-800F	1 1/4	43.2	13	35.5	12.7	55	38.7	0.33
WFC12-800F	1 1/2	49.1	13	41.2	12.7	63	38.7	0.43
WFC16-800F	2	61.1	16	52.7	19.1	75	51.1	0.71
WFC20-800F	2 1/2	77.1	16	65.9	19.1	95	51.1	1.17
WFC24-800F	3	90	16	78.1	19.1	110	51.1	1.50
Sch. 160								
WFC04-160F	1/2	22.2	13	12.3	9.5	34	35.5	0.17
WFC06-160F	3/4	27.7	13	16.2	9.5	42	35.5	0.25
WFC08-160F	1	34.5	13	21.2	12.7	52	38.7	0.42
WFC10-160F	1 1/4	43.2	13	29.9	12.7	60	38.7	0.49
WFC12-160F	1 1/2	49.1	16	34.4	12.7	68	44.7	0.70
WFC16-160F	2	61.1	16	43.1	19.1	85	51.1	1.32
WFC20-160F	2 1/2	77.1	16	57.3	19.1	100	51.1	1.60

注) 合金鋼、ステンレス鋼についてはC、L、M寸法が異なります。炭素鋼以外は寸法が異なるので、都度お問い合わせください。(Jシリーズになります。)
Note: Dimensions of C, L and M for alloy steel and stainless steel products deviate from the above dimensions. (contact us)

ハーフカップリング WHC / Half Coupling WHC

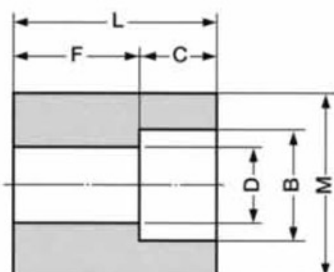

単位：mm/unit: mm

継手の呼び Part No.	呼び径 Nominal sizes	B	C	D	F	M	L	重量 (kg) Weight (kg)
Sch. 80								
WHC02-800F	1/4	14.3	10	9.4	15.9	22	25.9	0.055
WHC03-800F	3/8	17.8	10	12.7	17.5	26	27.5	0.077
WHC04-800F	1/2	22.2	10	16.1	22.2	32	32.2	0.14
WHC06-800F	3/4	27.7	13	21.4	23.8	38	36.8	0.20
WHC08-800F	1	34.5	13	27.2	28.6	46	41.6	0.31
WHC10-800F	1 1/4	43.2	13	35.5	30.2	55	43.2	0.42
WHC12-800F	1 1/2	49.1	13	41.2	31.8	63	44.8	0.57
WHC16-800F	2	61.1	16	52.7	41.3	75	57.3	0.91
WHC20-800F	2 1/2	77.1	16	65.9	42.9	95	58.9	1.56
WHC24-800F	3	90	16	78.1	44.5	110	60.5	2.04
Sch. 160								
WHC04-160F	1/2	22.2	13	12.3	22.2	34	35.2	0.19
WHC06-160F	3/4	27.7	13	16.2	23.8	42	36.8	0.30
WHC08-160F	1	34.5	13	21.2	28.6	52	41.6	0.52
WHC10-160F	1 1/4	43.2	13	29.9	30.2	60	43.2	0.64
WHC12-160F	1 1/2	49.1	16	34.4	31.8	68	47.8	0.89
WHC16-160F	2	61.1	16	43.1	41.3	85	57.3	1.71
WHC20-160F	2 1/2	77.1	16	57.3	42.9	100	58.9	2.18

注) 合金鋼、ステンレス鋼についてはC、L、M寸法が異なります。炭素鋼以外は寸法が異なるので、都度お問い合わせください。(Jシリーズになります。)
Note: Dimensions of C, L and M for alloy steel and stainless steel products deviate from the above dimensions. (contact us)

レジューサ WRC / Reducer WRC

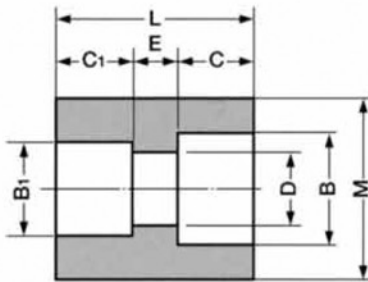
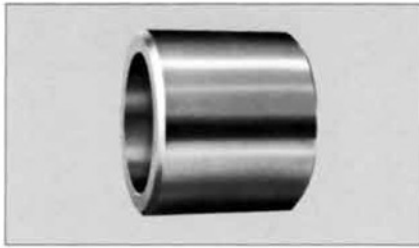

単位：mm/unit: mm

継手の呼び Part No.	呼び径 Nominal sizes	B	B ₁	C	C ₁	D	E	M	L	重量 (kg) Weight (kg)
Sch. 80										
WRC03-028F	3/8 × 1/4	17.8	14.3	10	10	9.4	6.4	26	26.4	0.074
WRC04-028F	1/2 × 1/4	22.2	14.3	10	10	9.4	9.5	32	29.5	0.14
WRC04-038F	1/2 × 3/8	22.2	17.8	10	10	12.7	9.5	32	29.5	0.13
WRC06-028F	3/4 × 1/4	27.7	14.3	13	10	9.4	12.5	38	35.5	0.24
WRC06-038F	3/4 × 3/8	27.7	17.8	13	10	12.7	12.5	38	35.5	0.22
WRC06-048F	3/4 × 1/2	27.7	22.2	13	10	16.1	12.5	38	35.5	0.20
WRC08-038F	1 × 3/8	34.5	17.8	13	10	12.7	15.7	46	38.7	0.37
WRC08-048F	1 × 1/2	34.5	22.2	13	10	16.1	15.7	46	38.7	0.35
WRC08-068F	1 × 3/4	34.5	27.7	13	13	21.4	12.7	46	38.7	0.31
WRC10-048F	1 1/4 × 1/2	43.2	22.2	13	10	16.1	15.7	55	38.7	0.52
WRC10-068F	1 1/4 × 3/4	43.2	27.7	13	13	21.4	12.7	55	38.7	0.47
WRC10-088F	1 1/4 × 1	43.2	34.5	13	13	27.2	12.7	55	38.7	0.42
WRC12-068F	1 1/2 × 3/4	49.1	27.7	13	13	21.4	12.7	63	38.7	0.66
WRC12-088F	1 1/2 × 1	49.1	34.5	13	13	27.2	12.7	63	38.7	0.60
WRC12-108F	1 1/2 × 1 1/4	49.1	43.2	13	13	35.5	12.7	63	38.7	0.51
WRC16-088F	2 × 1	61.1	34.5	16	13	27.2	22.1	75	51.1	1.21
WRC16-108F	2 × 1 1/4	61.1	43.2	16	13	35.5	22.1	75	51.1	1.08
WRC16-128F	2 × 1 1/2	61.1	49.1	16	13	41.2	22.1	75	51.1	0.98
WRC20-108F	2 1/2 × 1 1/4	77.1	43.2	16	13	35.5	22.1	95	51.1	1.94
WRC20-128F	2 1/2 × 1 1/2	77.1	49.1	16	13	41.2	22.1	95	51.1	1.83
WRC20-168F	2 1/2 × 2	77.1	61.1	16	16	52.7	19.1	95	51.1	1.56
WRC24-128F	3 × 1 1/2	90	49.1	16	13	41.2	22.1	110	51.1	2.59
WRC24-168F	3 × 2	90	61.1	16	16	52.7	19.1	110	51.1	2.32
WRC24-208F	3 × 2 1/2	90	77.1	16	16	65.9	19.1	110	51.1	1.92
Sch. 160										
WRC06-046F	3/4 × 1/2	27.7	22.2	13	13	12.3	9.5	42	35.5	0.28
WRC08-066F	1 × 3/4	34.5	27.7	13	13	16.2	12.7	52	38.7	0.47
WRC10-046F	1 1/4 × 1/2	43.2	22.2	13	13	12.3	12.7	60	38.7	0.66
WRC10-066F	1 1/4 × 3/4	43.2	27.7	13	13	16.2	12.7	60	38.7	0.63
WRC10-086F	1 1/4 × 1	43.2	34.5	13	13	21.2	12.7	60	38.7	0.58
WRC12-066F	1 1/2 × 3/4	49.1	27.7	16	13	16.2	15.7	68	44.7	0.95
WRC12-086F	1 1/2 × 1	49.1	34.5	16	13	21.2	15.7	68	44.7	0.90
WRC12-106F	1 1/2 × 1 1/4	49.1	43.2	16	13	29.9	15.7	68	44.7	0.80
WRC16-086F	2 × 1	61.1	34.5	16	13	21.2	22.1	85	51.1	1.75
WRC16-106F	2 × 1 1/4	61.1	43.2	16	13	29.9	22.1	85	51.1	1.64
WRC16-126F	2 × 1 1/2	61.1	49.1	16	16	34.4	19.1	85	51.1	1.53
WRC20-106F	2 1/2 × 1 1/4	77.1	43.2	16	13	29.9	22.1	100	51.1	2.29
WRC20-126F	2 1/2 × 1 1/2	77.1	49.1	16	16	34.4	19.1	100	51.1	2.19
WRC20-166F	2 1/2 × 2	77.1	61.1	16	16	43.1	19.1	100	51.1	1.98

注) 合金鋼、ステンレス鋼についてはC、L、M寸法が異なります。炭素鋼以外は寸法が異なるので、都度お問い合わせください。(Jシリーズになります。)
 Note: Dimensions of C, L and M for alloy steel and stainless steel products deviate from the above dimensions. (contact us)

WRM

差込み溶接形管継手 / Socket Weld Pipe Fittings

レジュージングインサート WRM / Reducing Insert WRM

単位: mm / unit: mm

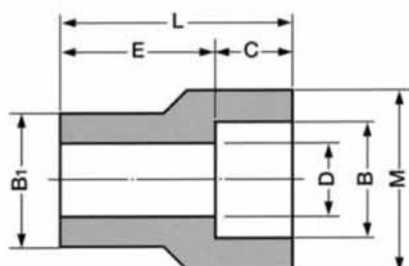

タイプ1 / Type 1

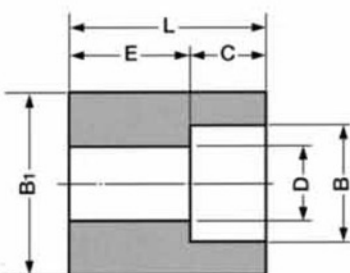

タイプ2 / Type 2

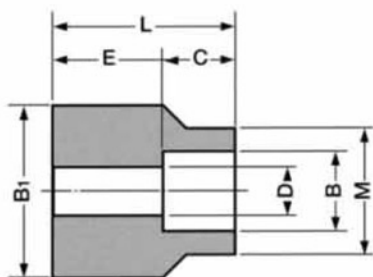

タイプ3 / Type 3

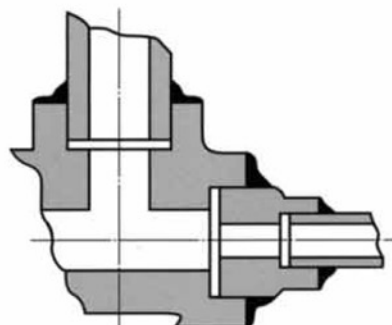

接続例 / Example of Connection

継手の呼び Part No.	呼び径 Nominal sizes	タイプ Type	B	B ₁	C	D	E	M	L	重量 (kg) Weight (kg)
Sch. 80										
WRM03-028J	3/8 × 1/4	1	14.3	17.3	10	9.4	21	22	31	0.049
WRM04-028J	1/2 × 1/4	2	14.3	21.7	10	9.4	15	—	25	0.051
WRM04-038J	1/2 × 3/8	1	17.8	21.7	10	12.7	24	26	34	0.071
WRM06-028J	3/4 × 1/4	2	14.3	27.2	10	9.4	19	—	29	0.11
WRM06-038J	3/4 × 3/8	2	17.8	27.2	10	12.7	19	—	29	0.093
WRM06-048J	3/4 × 1/2	1	22.2	27.2	10	16.1	26	32	36	0.12
WRM08-038J	1 × 3/8	3	17.8	34	10	12.7	28	26	38	0.18
WRM08-048J	1 × 1/2	2	22.2	34	10	16.1	22	—	32	0.16
WRM08-068J	1 × 3/4	1	27.7	34	13	21.4	29	38	42	0.19
WRM10-048J	1 1/4 × 1/2	3	22.2	42.7	10	16.1	32	32	42	0.32
WRM10-068J	1 1/4 × 3/4	2	27.7	42.7	13	21.4	24	—	37	0.29
WRM10-088J	1 1/4 × 1	1	34.5	42.7	13	27.2	28	46	41	0.27
WRM12-068J	1 1/2 × 3/4	3	27.7	48.6	13	21.4	36	38	49	0.47
WRM12-088J	1 1/2 × 1	2	34.5	48.6	13	27.2	26	—	39	0.36
WRM12-108J	1 1/2 × 1 1/4	1	43.2	48.6	13	35.5	33	55	46	0.36
WRM16-088J	2 × 1	3	34.5	60.5	13	27.2	35	46	48	0.71
WRM16-108J	2 × 1 1/4	2	43.2	60.5	13	35.5	29	—	42	0.57
WRM16-128J	2 × 1 1/2	1	49.1	60.5	13	41.2	33	63	46	0.54
WRM20-108J	2 1/2 × 1 1/4	3	43.2	76.3	13	35.7	47	55	60	1.34
WRM20-128J	2 1/2 × 1 1/2	3	49.1	76.3	13	41.2	42	63	55	1.16
WRM20-168J	2 1/2 × 2	2	61.1	76.3	16	52.7	39	—	55	0.94
WRM24-128J	3 × 1 1/2	3	49.1	89.1	13	41.2	51	63	64	2.01
WRM24-168J	3 × 2	3	61.1	89.1	16	52.7	43	75	59	1.56
WRM24-208J	3 × 2 1/2	1	77.1	89.1	16	65.9	44	95	60	1.36
Sch. 160										
WRM06-046J	3/4 × 1/2	1	22.2	27.2	13	12.3	26	34	39	0.16
WRM08-046J	1 × 1/2	2	22.2	34	13	12.3	22	—	35	0.19
WRM08-066J	1 × 3/4	1	27.7	34	13	16.2	29	42	42	0.26
WRM10-046J	1 1/4 × 1/2	3	22.2	42.7	13	12.3	29	34	42	0.37
WRM10-066J	1 1/4 × 3/4	2	27.7	42.7	13	16.2	27	—	40	0.32
WRM10-086J	1 1/4 × 1	1	34.5	42.7	13	21.2	32	52	45	0.43
WRM12-066J	1 1/2 × 3/4	3	27.7	48.6	13	16.2	35	42	48	0.55
WRM12-086J	1 1/2 × 1	1	34.5	48.6	13	21.2	38	52	51	0.58
WRM12-106J	1 1/2 × 1 1/4	1	43.2	48.6	13	29.9	36	60	49	0.53
WRM16-086J	2 × 1	3	34.5	60.5	13	21.2	39	52	52	0.92
WRM16-106J	2 × 1 1/4	2	43.2	60.5	13	29.9	37	—	50	0.83
WRM16-126J	2 × 1 1/2	1	49.1	60.5	16	34.4	38	70	54	0.88
WRM20-106J	2 1/2 × 1 1/4	3	43.2	76.3	13	29.9	46	60	59	1.58
WRM20-126J	2 1/2 × 1 1/2	3	49.1	76.3	16	34.4	46	68	62	1.58
WRM20-166J	2 1/2 × 2	1	61.1	76.3	16	43.1	54	85	70	1.74

SLD·SLE·STD

差込み溶接形管継手 / Socket Weld Pipe Fittings

特殊90° エルボ SLD / Special 90° Elbow SLD

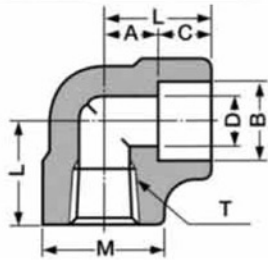
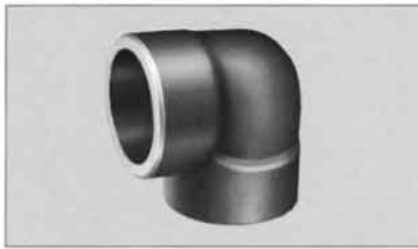

単位：mm/unit: mm

継手の呼び Part No.	呼び径 Nominal sizes	B	C	D	M	A	L	T (Rc)	重量 (kg) Weight (kg)
SLD02-028F	1/4	14.3	10	9.4	23	11.1	21.1	1/4	0.088
SLD03-038F	3/8	17.8	11	12.7	28	13.5	24.5	3/8	0.14
SLD04-048F	1/2	22.2	13	16.1	34	15.9	28.9	1/2	0.21
SLD06-068F	3/4	27.7	14	21.4	39	19.1	33.1	3/4	0.35
SLD08-088F	1	34.5	16	27.2	47	22.2	38.2	1	0.52
SLD10-108F	1 1/4	43.2	18	35.5	57	27.0	45	1 1/4	0.83
SLD12-128F	1 1/2	49.1	19	41.2	64	31.8	50.8	1 1/2	1.15
SLD16-168F	2	61.1	22	52.7	77	38.1	60.1	2	1.93

注) 合金鋼、ステンレス鋼についてはC、L、M寸法が異なります。炭素鋼以外は寸法が異なるので、都度お問い合わせください。(Jシリーズになります。)
Note: Dimensions of C, L and M for alloy steel and stainless steel products deviate from the above dimensions. (contact us)

特殊45° エルボ SLE / Special 45° Elbow SLE

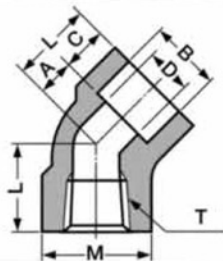

単位：mm/unit: mm

継手の呼び Part No.	呼び径 Nominal sizes	B	C	D	M	A	L	T (Rc)	重量 (kg) Weight (kg)
SLE02-028F	1/4	14.3	10	9.4	23	7.9	17.9	1/4	0.098
SLE03-038F	3/8	17.8	11	12.7	28	7.9	18.9	3/8	0.11
SLE04-048F	1/2	22.2	13	16.1	34	11.1	24.1	1/2	0.18
SLE06-068F	3/4	27.7	14	21.4	39	12.7	26.7	3/4	0.29
SLE08-088F	1	34.5	16	27.2	47	14.3	30.3	1	0.47
SLE10-108F	1 1/4	43.2	18	35.5	57	17.5	35.5	1 1/4	0.70
SLE12-128F	1 1/2	49.1	19	41.2	64	20.6	39.6	1 1/2	0.89
SLE16-168F	2	61.1	22	52.7	77	25.4	47.4	2	1.49

注) 合金鋼、ステンレス鋼についてはC、L、M寸法が異なります。炭素鋼以外は寸法が異なるので、都度お問い合わせください。(Jシリーズになります。)
Note: Dimensions of C, L and M for alloy steel and stainless steel products deviate from the above dimensions. (contact us)

特殊ティー STD / Special Tee STD

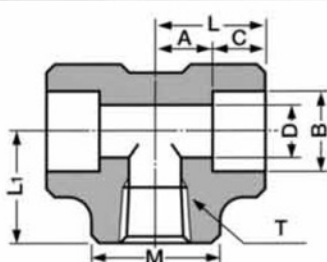

単位：mm/unit: mm

継手の呼び Part No.	呼び径 Nominal sizes	B	C	D	M	A	L	L ₁	T (Rc)	重量 (kg) Weight (kg)
STD02-028F	1/4	14.3	10	9.4	23	11.1	21.1	21.1	1/4	0.12
STD03-038F	3/8	17.8	11	12.7	28	13.5	24.5	24.5	3/8	0.20
STD04-048F	1/2	22.2	13	16.1	34	15.9	28.9	28.9	1/2	0.27
STD06-068F	3/4	27.7	14	21.4	39	19.1	33.1	33.1	3/4	0.41
STD08-088F	1	34.5	16	27.2	47	22.2	38.2	38.2	1	0.66
STD10-108F	1 1/4	43.2	18	35.5	57	27	45	45	1 1/4	0.98
STD12-128F	1 1/2	49.1	19	41.2	64	31.8	50.8	50.8	1 1/2	1.29
STD16-168F	2	61.1	22	52.7	77	38.1	60.1	60.1	2	2.05

注) 合金鋼、ステンレス鋼についてはC、L、M寸法が異なります。炭素鋼以外は寸法が異なるので、都度お問い合わせください。(Jシリーズになります。)
Note: Dimensions of C, L and M for alloy steel and stainless steel products deviate from the above dimensions. (contact us)

SFD・WLE・SLF

差込み溶接形管継手 / Socket Weld Pipe Fittings

特殊カップリング SFD / Special Coupling SFD

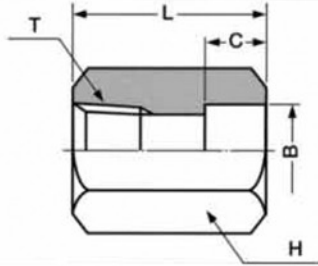
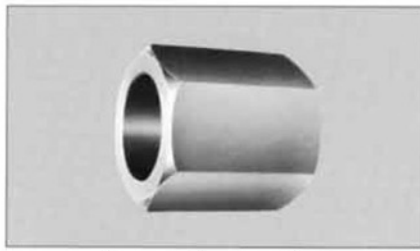

単位: mm / unit: mm

継手の呼び Part No.	呼び径 Nominal sizes	B	C	L	H (六角) H (HEX)	T (Rc)	重量 (kg) Weight (kg)
SFD02-020J	1/4	14.3	10	30	22	1/4	0.069
SFD03-030J	3/8	17.8	10	30	27	3/8	0.10
SFD04-040J	1/2	22.2	10	40	32	1/2	0.18
SFD06-060J	3/4	27.7	13	43	41	3/4	0.32
SFD08-080J	1	34.5	13	50	46	1	0.41
SFD10-100J	1 1/4	43.2	13	55	55	1 1/4	0.60
SFD12-120J	1 1/2	49.1	13	55	65	1 1/2	0.89
SFD16-160J	2	61.1	16	64	75	2	1.17

シリンダ用エルボ WLF / Cylinder Elbow WLF

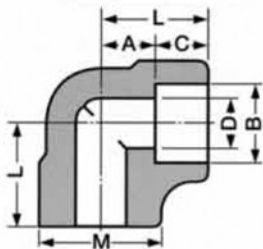

単位: mm / unit: mm

継手の呼び Part No.	呼び径 Nominal sizes	B	C	D	M	A	L	重量 (kg) Weight (kg)
WLF02-000F	1/4	14.3	10	9	23	11.1	21.1	0.089
WLF03-000F	3/8	17.8	11	11.5	28	13.5	24.5	0.14
WLF04-000F	1/2	22.2	13	15	34	15.9	28.9	0.23
WLF06-000F	3/4	27.7	14	19.5	39	19.1	33.1	0.38
WLF08-000F	1	34.5	16	25	47	22.2	38.2	0.58

注)合金鋼、ステンレス鋼についてはC、L、M寸法が異なります。炭素鋼以外は寸法が異なるので、都度お問い合わせください。(Jシリーズになります。)
Note: Dimensions of C, L and M for alloy steel and stainless steel products deviate from the above dimensions. (contact us)

シリンダ用エルボ SLF / Cylinder Elbow SLF

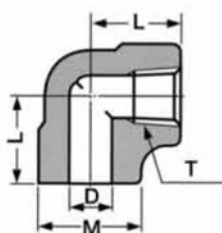

単位: mm / unit: mm

継手の呼び Part No.	呼び径 Nominal sizes	D	M	L	T (Rc)	重量 (kg) Weight (kg)
SLF02-000F	1/4	9	23	21.1±0.8	1/4	0.09
SLF03-000F	3/8	11.5	28	24.5±1	3/8	0.14
SLF04-000F	1/2	15	34	28.9±1	1/2	0.22
SLF06-000F	3/4	19.5	39	33.1±1	3/4	0.37
SLF08-000F	1	25	47	38.2±1.5	1	0.54

注)合金鋼、ステンレス鋼についてはC、L、M寸法が異なります。炭素鋼以外は寸法が異なるので、都度お問い合わせください。(Jシリーズになります。)
Note: Dimensions of C, L and M for alloy steel and stainless steel products deviate from the above dimensions. (contact us)

WBA・WBR 差込み溶接形管継手 / Socket Weld Pipe Fittings

ボスA形 WBA / Boss Type A WBA

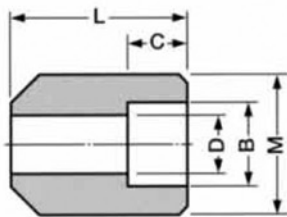

単位：mm/unit: mm

継手の呼び Part No.	呼び径 Nominal sizes	B	C	D	M	L	重量 (kg) Weight (kg)
Sch. 80							
WBA02-800J	1/4	14.3	10	9.4	22	40	0.085
WBA03-800J	3/8	17.8	10	12.7	26	47	0.13
WBA04-800J	1/2	22.2	10	16.1	32	47	0.19
WBA06-800J	3/4	27.7	13	21.4	38	50	0.26
WBA08-800J	1	34.5	13	27.2	46	50	0.36
WBA10-800J	1 1/4	43.2	13	35.5	55	50	0.45
WBA12-800J	1 1/2	49.1	13	41.2	65	50	0.65
WBA16-800J	2	61.1	16	52.7	75	60	0.88

ボスR形 WBR / Boss Type R WBR

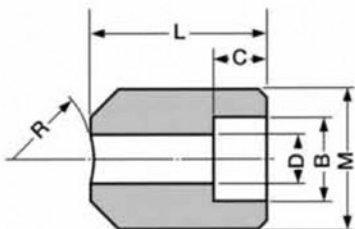

単位：mm/unit: mm

継手の呼び Part No.	呼び径 Nominal sizes	B	C	D	M	L	R	重量 (kg) Weight (kg)
Sch. 80								
WBR02-800J	1/4	14.3	10	9.4	22	40	25	0.085
WBR03-800J	3/8	17.8	10	12.7	26	47	25	0.13
WBR04-800J	1/2	22.2	10	16.1	32	47	30	0.19
WBR06-800J	3/4	27.7	13	21.4	38	50	30	0.26
WBR08-800J	1	34.5	13	27.2	46	50	40	0.35
WBR10-800J	1 1/4	43.2	13	35.5	55	50	45	0.45
WBR12-800J	1 1/2	49.1	13	41.2	65	50	55	0.63
WBR16-800J	2	61.1	16	52.7	75	60	60	0.81

WCA 差込み溶接形管継手 / Socket Weld Pipe Fittings

キャップ WCA / Cap WCA

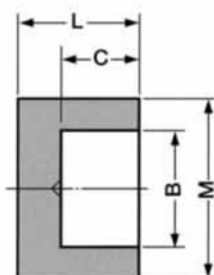
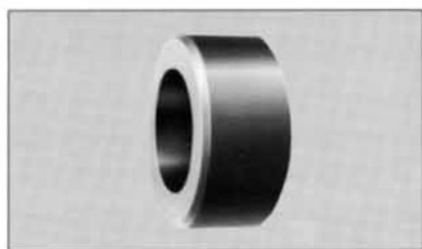

単位 : mm / unit: mm

継手の呼び Part No.	呼び径 Nominal sizes	B	C	M	L	重量 (kg) Weight (kg)
Sch. 80						
WCA02-800F	1/4	14.3	10	22	14.5	0.047
WCA03-800F	3/8	17.8	10	26	15.0	0.063
WCA04-800F	1/2	22.2	10	32	19.5	0.095
WCA06-800F	3/4	27.7	13	38	20.0	0.16
WCA08-800F	1	34.5	13	46	21.3	0.25
WCA10-800F	1 1/4	43.2	13	55	22.6	0.41
WCA12-800F	1 1/2	49.1	13	63	23.5	0.54
WCA16-800F	2	61.1	16	75	28.2	0.88
WCA20-800F	2 1/2	77.1	16	95	31.3	1.64
WCA24-800F	3	90	16	110	33.3	2.19
Sch. 160						
WCA04-160F	1/2	22.2	13	34	20.2	0.15
WCA06-160F	3/4	27.7	13	42	21.8	0.23
WCA08-160F	1	34.5	13	52	23.6	0.41
WCA10-160F	1 1/4	43.2	13	60	24.8	0.56
WCA12-160F	1 1/2	49.1	16	68	29.3	0.79
WCA16-160F	2	61.1	16	85	32.4	1.37
WCA20-160F	2 1/2	77.1	16	100	35.2	2.07

SLA・SLC ねじ込み形管継手 / Threaded Pipe Fittings

90° エルボ SLA / 90° Elbow SLA

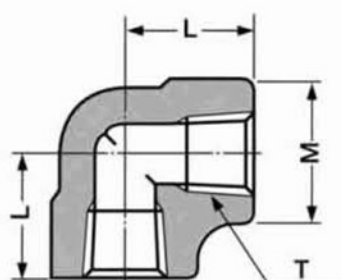

単位：mm/unit: mm

継手の呼び Part No.	T (Rc)	M	L	重量 (kg) Weight (kg)
SLA02-000F	1/4	23	21.1	0.09
SLA03-000F	3/8	28	24.5	0.16
SLA04-000F	1/2	34	28.9	0.25
SLA06-000F	3/4	39	33.1	0.35
SLA08-000F	1	47	38.2	0.57
SLA10-000F	1 1/4	57	45.0	0.95
SLA12-000F	1 1/2	64	50.8	1.28
SLA16-000F	2	77	60.1	1.89

注) 合金鋼、ステンレス鋼についてはL寸法が異なります。炭素鋼以外は寸法が異なるので、都度お問い合わせください。(Jシリーズになります。)
Note: L dimension for alloy steel and stainless steel is not the same. Stainless steel products deviate from the above dimensions. (contact us)

メスオスエルボ SLC / Street Elbow SLC

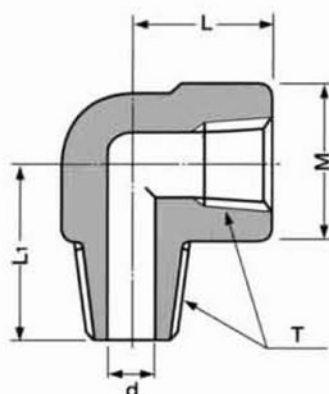

単位：mm/unit: mm

継手の呼び Part No.	T (R×Rc)	d	M	L	L ₁	重量 (kg) Weight (kg)
SLC02-000J	1/4	6	22	14	27	0.057
SLC03-000J	3/8	9	26	23	29	0.10
○ SLC04-000J	1/2	12	32	26	36	0.19
○ SLC06-000J	3/4	16	38	31	42	0.29
○ SLC08-000J	1	20	44	33	46	0.39
○ SLC10-000J	1 1/4	28	55	36	54.5	0.77
○ SLC12-000J	1 1/2	32	65	38	59.5	1.25
○ SLC16-000J	2	40	80	46	72	1.95

○P処理品 / Parkerizing

注) 合金鋼、ステンレス鋼についてはL寸法が異なります。炭素鋼以外は寸法が異なるので、都度お問い合わせください。(Jシリーズになります。)
Note: L dimension for alloy steel and stainless steel is not the same. Stainless steel products deviate from the above dimensions. (contact us)

SLB·STA

ねじ込み形管継手 / Threaded Pipe Fittings

45° エルボ SLB / 45° Elbow SLB

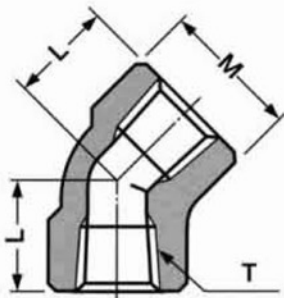

単位：mm / unit: mm

継手の呼び Part No.	T (Rc)	M	L	重量 (kg) Weight (kg)
SLB02-000F	1/4	23	17.9	0.09
SLB03-000F	3/8	28	18.9	0.13
SLB04-000F	1/2	34	24.1	0.23
SLB06-000F	3/4	39	26.7	0.31
SLB08-000F	1	47	30.3	0.50
SLB10-000F	1 1/4	57	35.5	0.75
SLB12-000F	1 1/2	64	39.6	0.95
SLB16-000F	2	77	47.4	1.57

注) 合金鋼、ステンレス鋼についてはL寸法が異なります。炭素鋼以外は寸法が異なるので、都度お問い合わせください。(Jシリーズになります。)
Note: L dimension for alloy steel and stainless steel is not the same. Stainless steel products deviate from the above dimensions. (contact us)

ティー STA / Tee STA

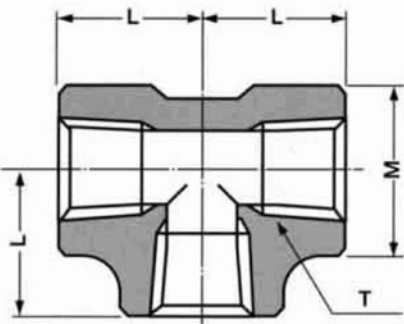

単位：mm / unit: mm

継手の呼び Part No.	T (Rc)	M	L	重量 (kg) Weight (kg)
STA02-000F	1/4	23	21.1	0.12
STA03-000F	3/8	28	24.5	0.21
STA04-000F	1/2	34	28.9	0.33
STA06-000F	3/4	39	33.1	0.45
STA08-000F	1	47	38.2	0.71
STA10-000F	1 1/4	57	45.0	1.18
STA12-000F	1 1/2	64	50.8	1.56
STA16-000F	2	77	60.1	2.45

注) 合金鋼、ステンレス鋼についてはL寸法が異なります。炭素鋼以外は寸法が異なるので、都度お問い合わせください。(Jシリーズになります。)
Note: L dimension for alloy steel and stainless steel is not the same. Stainless steel products deviate from the above dimensions. (contact us)

SFC・SRC

ねじ込み形管継手 / Threaded Pipe Fittings

カップリング SFC / Coupling SFC

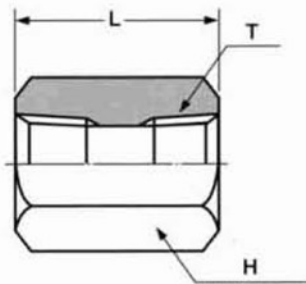
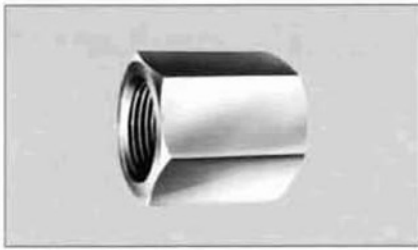

単位：mm/unit: mm

継手の呼び Part No.	T (Rc)	H (六角) H (HEX)	L	重量 (kg) Weight (kg)
SFC01-000J	1/8	19	30	0.059
SFC02-000F	1/4	22	30	0.075
SFC03-000F	3/8	24	30	0.074
SFC04-000F	1/2	32	40	0.19
SFC06-000F	3/4	36	42	0.21
SFC08-000F	1	46	50	0.43
SFC10-000F	1 1/4	55	55	0.61
SFC12-000F	1 1/2	65	55	0.89
SFC16-000F	2	75	64	1.17

注) 合金鋼、ステンレス鋼についてはL寸法が異なります。炭素鋼以外は寸法が異なるので、都度お問い合わせください。(Jシリーズになります。)
Note: L dimensions for alloy steel and stainless steel products deviate from the above dimensions. (contact us)

レジューサ SRC / Reducer SRC

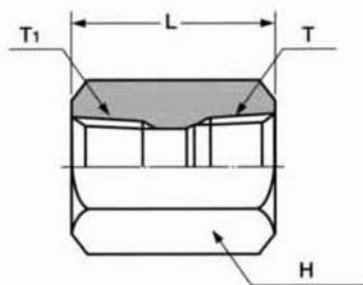

単位：mm/unit: mm

継手の呼び Part No.	T×T ₁ (Rc)	H (六角) H (HEX)	L	重量 (kg) Weight (kg)
SRC03-020F	3/8 × 1/4	24	30	0.083
SRC04-020F	1/2 × 1/4	32	40	0.22
SRC04-030F	1/2 × 3/8	32	40	0.21
SRC06-020F	3/4 × 1/4	36	42	0.28
SRC06-030F	3/4 × 3/8	36	42	0.27
SRC06-040F	3/4 × 1/2	36	42	0.25
SRC08-030F	1 × 3/8	46	50	0.55
SRC08-040F	1 × 1/2	46	50	0.53
SRC08-060F	1 × 3/4	46	50	0.50
SRC10-040F	1 1/4 × 1/2	55	55	0.81
SRC10-060F	1 1/4 × 3/4	55	55	0.77
SRC10-080F	1 1/4 × 1	55	55	0.71
SRC12-060F	1 1/2 × 3/4	65	55	1.14
SRC12-080F	1 1/2 × 1	65	55	1.08
SRC12-100F	1 1/2 × 1 1/4	65	55	0.97
SRC16-080F	2 × 1	75	64	1.64
SRC16-100F	2 × 1 1/4	75	64	1.51
SRC16-120F	2 × 1 1/2	75	64	1.41

注) 合金鋼、ステンレス鋼についてはL寸法が異なります。炭素鋼以外は寸法が異なるので、都度お問い合わせください。(Jシリーズになります。)
Note: L dimensions for alloy steel and stainless steel products deviate from the above dimensions. (contact us)

SBU·SNP

ねじ込み形管継手 / Threaded Pipe Fittings

ブッシング SBU / Bushing SBU



単位: mm / unit: mm

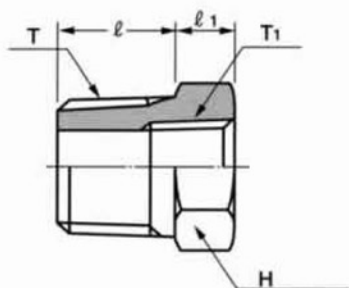

継手の呼び Part No.	T×T ₁ (R×Rc)	H (六角) H (HEX)	ℓ	ℓ ₁	重量 (kg) Weight (kg)
SBU03-020F	3/8 × 1/4	19	14	8	0.025
○ SBU04-020F	1/2 × 1/4	24	17	9	0.06
○ SBU04-030F	1/2 × 3/8	24	17	9	0.046
○ SBU06-020F	3/4 × 1/4	30	19	10	0.12
○ SBU06-030F	3/4 × 3/8	30	19	10	0.10
○ SBU06-040F	3/4 × 1/2	30	19	10	0.079
○ SBU08-020F	1 × 1/4	36	22	11	0.22
○ SBU08-030F	1 × 3/8	36	22	11	0.20
○ SBU08-040F	1 × 1/2	36	22	11	0.18
○ SBU08-060F	1 × 3/4	36	22	11	0.13
○ SBU10-040F	1 1/4 × 1/2	46	24	12	0.37
○ SBU10-060F	1 1/4 × 3/4	46	24	12	0.31
○ SBU10-080F	1 1/4 × 1	46	24	12	0.23
○ SBU12-040F	1 1/2 × 1/2	50	24	14	0.51
○ SBU12-060F	1 1/2 × 3/4	50	24	14	0.46
○ SBU12-080F	1 1/2 × 1	50	24	14	0.37
○ SBU12-100F	1 1/2 × 1 1/4	50	24	14	0.22
○ SBU16-060F	2 × 3/4	65	28	16	0.94
○ SBU16-080F	2 × 1	65	28	16	0.90
○ SBU16-100F	2 × 1 1/4	65	28	16	0.68
○ SBU16-120F	2 × 1 1/2	65	28	16	0.54

○P処理品 / Parkerizing

ニップル SNP / Nipple SNP



単位: mm / unit: mm

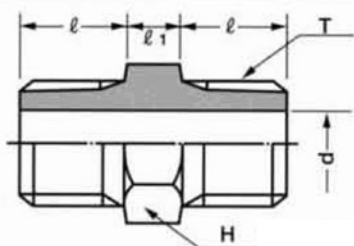

継手の呼び Part No.	T (R)	d	H (六角) H (HEX)	ℓ	ℓ ₁	重量 (kg) Weight (kg)
SNP01-000J	1/8	4	12	9	6	0.013
SNP02-000F	1/4	7	17	13	8	0.032
SNP03-000F	3/8	9	19	14	8	0.048
○ SNP04-000F	1/2	12	24	17	9	0.083
○ SNP06-000F	3/4	16	30	19	10	0.14
○ SNP08-000F	1	20	36	22	11	0.26
○ SNP10-000F	1 1/4	28	46	24	12	0.41
○ SNP12-000F	1 1/2	32	50	24	14	0.53
○ SNP16-000F	2	40	65	28	16	0.99

○P処理品 / Parkerizing

SRN・SSS ねじ込み形管継手 / Threaded Pipe Fittings

径違いニップル SRN / Reducing Nipple SRN

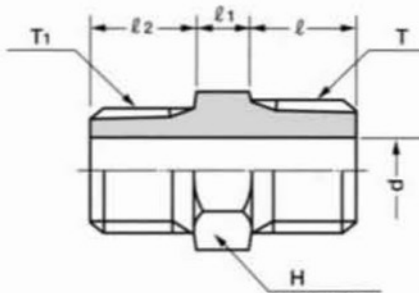

単位：mm/unit: mm

継手の呼び Part No.	T×T ₁ (R)	d	H (六角) H (HEX)	ℓ	ℓ ₁	ℓ ₂	重量 (kg) Weight (kg)
SRN03-020F	3/8 × 1/4	7	19	14	8	13	0.045
○ SRN04-020F	1/2 × 1/4	7	24	17	9	13	0.078
○ SRN04-030F	1/2 × 3/8	9	24	17	9	14	0.079
○ SRN06-020F	3/4 × 1/4	7	30	19	10	13	0.13
○ SRN06-030F	3/4 × 3/8	9	30	19	10	14	0.14
○ SRN06-040F	3/4 × 1/2	12	30	19	10	17	0.14
○ SRN08-030F	1 × 3/8	9	36	22	11	14	0.25
○ SRN08-040F	1 × 1/2	12	36	22	11	17	0.25
○ SRN08-060F	1 × 3/4	16	36	22	11	19	0.25
○ SRN10-040F	1 1/4 × 1/2	12	46	24	12	17	0.45
○ SRN10-060F	1 1/4 × 3/4	16	46	24	12	19	0.44
○ SRN10-080F	1 1/4 × 1	20	46	24	12	22	0.44
○ SRN12-060F	1 1/2 × 3/4	16	50	24	14	19	0.59
○ SRN12-080F	1 1/2 × 1	20	50	24	14	22	0.59
○ SRN12-100F	1 1/2 × 1 1/4	28	50	24	14	24	0.55
○ SRN16-080F	2 × 1	20	65	28	16	22	1.09
○ SRN16-100F	2 × 1 1/4	28	65	28	16	24	1.03
○ SRN16-120F	2 × 1 1/2	32	65	28	16	24	1.01

○P処理品 / Parkerizing

メスオスソケットA形 SSS / Street Socket Type A SSS

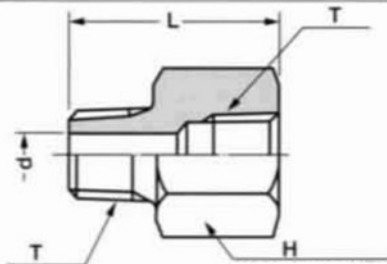

単位：mm/unit: mm

継手の呼び Part No.	T (R×Rc)	d	L	H (六角) H (HEX)	重量 (kg) Weight (kg)
SSS02-020J	1/4	7	33	22	0.058
SSS03-030J	3/8	9	36	24	0.075
○ SSS04-040J	1/2	12	45	32	0.16
○ SSS06-060J	3/4	16	50	36	0.22
○ SSS08-080J	1	20	58	46	0.42
○ SSS10-100J	1 1/4	28	67	55	0.65
○ SSS12-120J	1 1/2	32	69	65	0.96
○ SSS16-160J	2	40	79	75	1.39

○P処理品 / Parkerizing

SSS・SSF・SPA ねじ込み形管継手 / Threaded Pipe Fittings

メスオスソケットB形 SSS / Street Socket Type B SSS

単位: mm / unit: mm

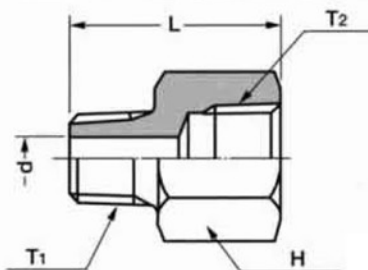

継手の呼び Part No.	T ₁ ×T ₂ (R×Rc)	d	L	H (六角) H (HEX)	重量 (kg) Weight (kg)
SSS02-030J	1/4 × 3/8	7	35	24	0.064
SSS03-040J	3/8 × 1/2	9	41	32	0.15
○ SSS04-060J	1/2 × 3/4	12	48	36	0.20
○ SSS06-080J	3/4 × 1	16	55	46	0.39
○ SSS08-100J	1 × 1 1/4	20	64	55	0.63
○ SSS10-120J	1 1/4 × 1 1/2	28	69	65	0.94
○ SSS12-160J	1 1/2 × 2	32	75	75	1.31

○P処理品 / Parkerizing

メスオスソケットC形 SSF / Street Socket Type C SSF

単位: mm / unit: mm

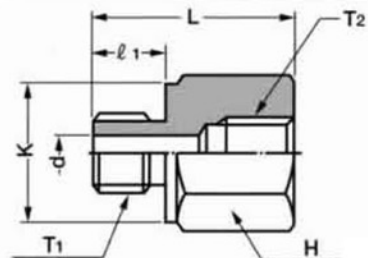

継手の呼び Part No.	T ₁ (G)	T ₂ (Rc)	d	K	ℓ ₁	L	H (六角) H (HEX)	O- Ring	重量 (kg) Weight (kg)
SSF02-020J	1/4	1/4	6	19	12	33	22	P11	0.061
SSF03-030J	3/8	3/8	8	22	12	35	24	P14	0.076
SSF04-040J	1/2	1/2	12	27	14	42	32	P18	0.16
SSF06-060J	3/4	3/4	16	36	16	47	36	P24	0.21
SSF08-080J	1	1	22	41	18	55	46	P29	0.40
SSF10-100J	1 1/4	1 1/4	28	50	20	63	55	P38	0.64
SSF12-120J	1 1/2	1 1/2	31	55	21	66	65	P44	0.96
SSF16-160J	2	2	36	75	25	76	75	P56	1.39

六角穴付プラグ SPA / Hollow hex Plug SPA

単位: mm / unit: mm

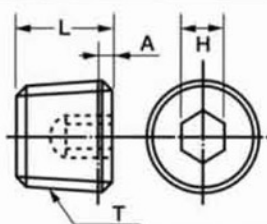

継手の呼び Part No.	T (R)	H	L	A	重量 (kg) Weight (kg)
◆ SPA01-000J	1/8	5	7	0.45	0.003
◆ SPA02-000J	1/4	6	9	0.7	0.008
◆ SPA03-000J	3/8	8	10	0.7	0.012
◆ SPA04-000J	1/2	10	12	0.9	0.024
◆ SPA06-000J	3/4	14	14	0.9	0.041
◆ SPA08-000J	1	17	16.5	1.1	0.088
◆ SPA10-000J	1 1/4	22	19	1.1	0.14
◆ SPA12-000J	1 1/2	22	20	1.1	0.23
◆ SPA16-000J	2	27	22	1.1	0.35

◆黒染 / Triiron tetraoxide

材質: 炭素鋼 / Material: S45C or S25C
Aは基準径の位置を示す。 / A indicates the position of standard bore

SPB・SPE・SPC ねじ込み形管継手 / Threaded Pipe Fittings

六角プラグ(テーパねじ) SPB / Hexagon Head Plug SPB

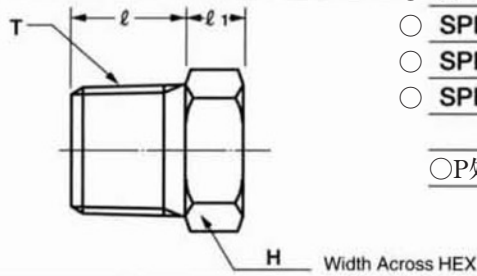

単位: mm/unit: mm

継手の呼び Part No.	T (R)	H (六角) H (HEX)	l	l ₁	重量 (kg) Weight (kg)
SPB02-000F	1/4	17	13	8	0.029
SPB03-000F	3/8	19	14	8	0.043
○ SPB04-000F	1/2	24	17	9	0.077
○ SPB06-000F	3/4	30	19	10	0.13
○ SPB08-000F	1	36	22	11	0.25
○ SPB10-000F	1 1/4	46	24	12	0.45
○ SPB12-000F	1 1/2	50	24	14	0.60
○ SPB16-000F	2	65	28	16	1.11

○P処理品 / Parkerizing

六角プラグ(平行ねじ) SPE / Hexagon Head Plug SPE

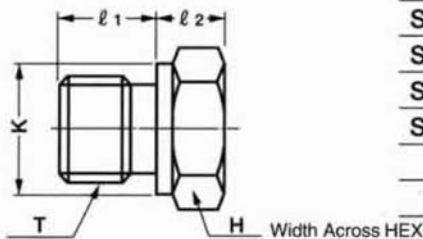
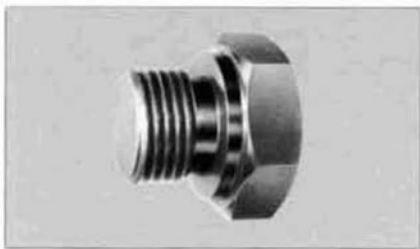

単位: mm/unit: mm

継手の呼び Part No.	T (G)	l ₁	l ₂	K	H (六角) H (HEX)	O- Ring	重量 (kg) Weight (kg)
SPE01-000J	1/8	8	7	14	14	P 8	0.012
SPE02-000J	1/4	12	9	19	19	P11	0.032
SPE03-000J	3/8	12	10	21	22	P14	0.049
SPE04-000J	1/2	14	13	27	27	P18	0.095
SPE06-000J	3/4	16	16	36	36	P24	0.20
SPE08-000J	1	18	18	41	41	P29	0.31
SPE10-000J	1 1/4	20	21	50	50	P38	0.55
SPE12-000J	1 1/2	21	21	55	55	P44	0.70
SPE16-000J	2	25	23	75	75	P56	1.38

四角頭付プラグ SPC / Square Head Plug SPC

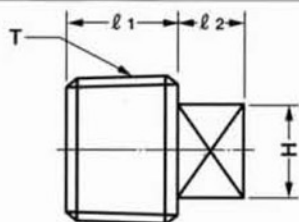

単位: mm/unit: mm

継手の呼び Part No.	T (R)	H	l ₁	l ₂	重量 (kg) Weight (kg)
SPC01-000J	1/8	7	9	7	0.007
SPC02-000J	1/4	9	12	8	0.016
SPC03-000J	3/8	12	13	9	0.03
○ SPC04-000J	1/2	14	16	10	0.054
○ SPC06-000J	3/4	17	18	11	0.096
○ SPC08-000J	1	19	20	12	0.16
○ SPC10-000J	1 1/4	24	22	13	0.28
○ SPC12-000J	1 1/2	27	22	14	0.37
○ SPC16-000J	2	32	26	15	0.66

○P処理品 / Parkerizing

材質: 炭素鋼 / Material: S10 or S25C

SBA・SBR

ねじ込み形管継手 / Threaded Pipe Fittings

ボスA形 SBA / Boss Type A SBA

単位：mm / unit: mm

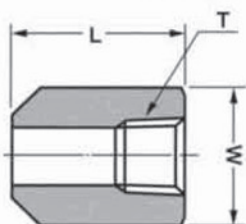
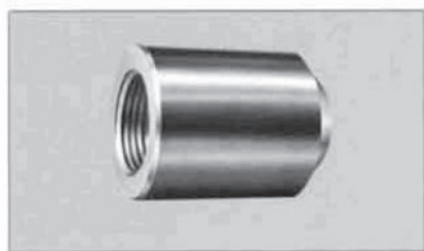

継手の呼び Part No.	T (Rc)	M	L	重量 (kg) Weight (kg)
SBA02-000J	1/4	22	40	0.084
SBA03-000J	3/8	26	50	0.14
SBA04-000J	1/2	32	50	0.20
SBA06-000J	3/4	38	50	0.26
SBA08-000J	1	46	50	0.35
SBA10-000J	1 1/4	55	50	0.44
SBA12-000J	1 1/2	65	50	0.63
SBA16-000J	2	75	60	0.86

ボスR形 SBR / Boss Type R SBR

単位：mm / unit: mm

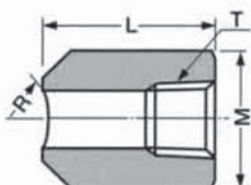

継手の呼び Part No.	サイズ SIZE	T (Rc)	M	L	R	重量 (kg) Weight (kg)
SBR02-000J	1/4	1/4	22	40	25	0.084
SBR03-000J	3/8	3/8	26	50	25	0.14
SBR04-000J	1/2	1/2	32	50	30	0.20
SBR06-000J	3/4	3/4	38	50	30	0.26

SCA・SMC

ねじ込み形管継手 / Threaded Pipe Fittings

キャップ SCA / Cap SCA

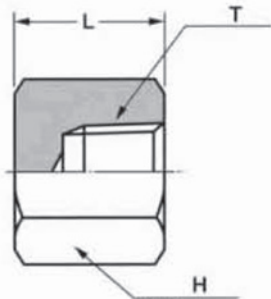

単位：mm/unit: mm

継手の呼び Part No.	T (Rc)	H (六角) H (HEX)	L	重量 (kg) Weight (kg)
SCA01-000J	1/8	19	21	0.042
SCA02-000F	1/4	22	21	0.056
SCA03-000F	3/8	24	21	0.059
SCA04-000F	1/2	32	28	0.15
SCA06-000F	3/4	36	30	0.18
SCA08-000F	1	46	35	0.36
SCA10-000F	1 1/4	55	39	0.53
SCA12-000F	1 1/2	65	40	0.79
SCA16-000F	2	75	47	1.16

注) 炭素鋼以外は寸法が異なるので、都度お問い合わせください。(Jシリーズになります。)
Note: Stainless steel products deviate from the above dimensions. (contact us)

丸ソケット SMC / Socket SMC

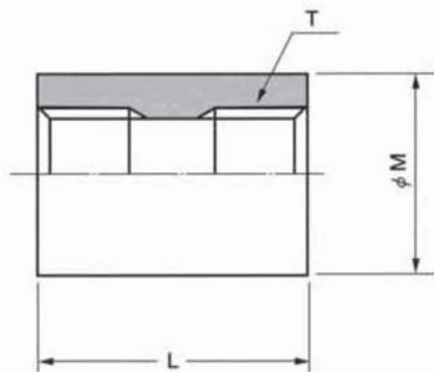

単位：mm/unit: mm

継手の呼び Part No.	T (Rc)	M	L	重量 (kg) Weight (kg)
SMC02-000F	1/4	22	30	0.062
SMC03-000F	3/8	26	30	0.079
SMC04-000F	1/2	32	40	0.16
SMC06-000F	3/4	38	42	0.21
SMC08-000F	1	46	50	0.34
SMC10-000F	1 1/4	55	55	0.47
SMC12-000F	1 1/2	63	55	0.62
SMC16-000F	2	75	64	0.89

注) 炭素鋼以外は寸法が異なるので、都度お問い合わせください。(Jシリーズになります。)
Note: Stainless steel products deviate from the above dimensions. (contact us)

SAP·SGA

ねじ込み形管継手 / Threaded Pipe Fittings

エア抜きバルブ SAP / Air Bleeding Valve SAP



単位: mm / unit: mm

継手の呼び Part No.	T (R)	D	d	h (六角穴) h (HEX Hole)	H ₁ (六角) H ₁ (HEX)	H (六角) H (HEX)	L	鋼球 Nominal Sizes of Steel Ball	重量 (kg) Weight (kg)
SAP01-000J	1/8	4	3	6	13	14	51	7/32	0.046
SAP02-000J	1/4	4	3	6	13	14	53	7/32	0.056
SAP03-000J	3/8	6	4	10	19	27	66	5/16	0.20
SAP04-000J	1/2	6	4	10	19	27	69	5/16	0.22

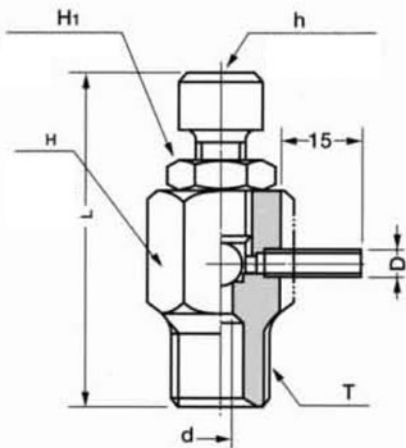

注) 炭素鋼以外は寸法が異なるので、都度お問い合わせください。(Jシリーズになります。)
Note: Stainless steel products deviate from the above dimensions. (contact us)

圧力計用アダプタ SGA / Adapter for Pressure Gauge SGA



単位: mm / unit: mm

継手の呼び Part No.	H ₁ (六角) H ₁ (HEX)	H ₂ (六角) H ₂ (HEX)	L	T ₁ (R)	T ₂ (G)	適用ガスケット Applicable Gasket	重量 (kg) Weight (kg)
SGA02-000J	17	19	39	1/4	1/4	KP-B-01	0.060
SGA03-000J	22	22	42	3/8	3/8	P6	0.080
SGA04-000J	24	27	49	1/2	1/2	P6	0.12

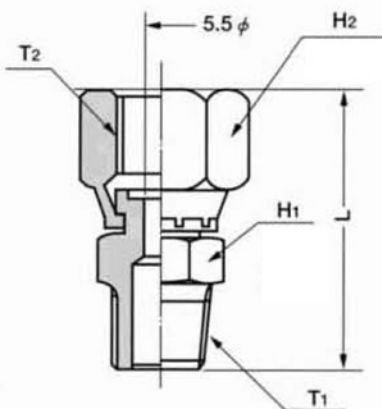

注) 適用ガスケット材質: サイズ 1/4: クロム皮
3/8, 1/2: JIS B2401-1B (Oリング)
炭素鋼以外は寸法が異なるので、都度お問い合わせください。(Jシリーズになります。)
Note: Applicable gasket material: Size 1/4: Chrome skin
Size 3/8, 1/2: JIS B2401-1B (O-ring)
Stainless steel products deviate from the above dimensions. (contact us)

WUA 差込み溶接形管継手 / Socket Weld Pipe Fittings

ユニオンA形 WUA / Union Type A WUA

単位：mm/unit: mm

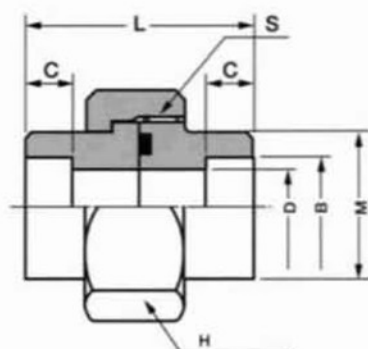

継手の呼び Part No.	呼び径 Nominal sizes	B	C	D	M	L	H (八角) H (OCT)	S	O-Ring	重量 (kg) Weight (kg)
WUA02-000J	1/4	14.3	10	9.4	22	40	36	M30X2	P18	0.18
WUA03-000J	3/8	17.8	10	12.7	27	41	41	M36X2	P20	0.24
WUA04-000J	1/2	22.2	10	16.1	32	47	46	M39X2	G25	0.34
WUA06-000J	3/4	27.7	13	21.4	38	53	55	M48X2	G30	0.56
WUA08-000J	1	34.5	13	27.2	47	59	65	M56X2	G35	0.82
WUA10-000J	1 1/4	43.2	13	35.5	58	64	80	M68X2	G45	1.36
WUA12-000J	1 1/2	49.1	13	41.2	63	76	85	M72X2	G50	1.77
WUA16-000J	2	61.1	16	52.7	81	76	104	M90X2	G65	2.60

注) O-RingはJIS B2401-1Bです。定格圧力:21MPa(210kgf/cm²)
 使用温度:120℃以下
 炭素鋼以外は寸法が異なるので、都度お問い合わせください。(Jシリーズになります。)
 Note; O-ring is JIS B2401-1B. Rated pressure: 21MPa (210kgf/cm²)
 Operating temperature: Less than 120℃
 Stainless steel products deviate from the above dimensions. (contact us)

WUB・WUC

差込み溶接形管継手 / Socket Weld Pipe Fittings

ユニオンB形 WUB / Union Type B WUB

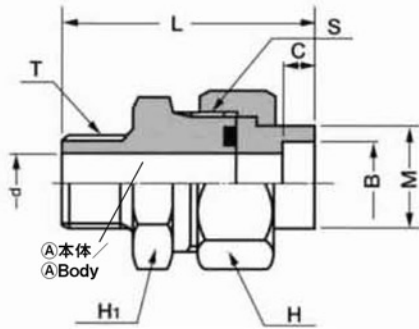

単位: mm / unit: mm

継手の呼び Part No.	呼び径 Nominal sizes	B	C	d	M	L	H (八角) H (OCT)	H ₁ (六角) H ₁ (HEX)	T (R)	S	O-Ring	重量 (kg) Weight (kg)
WUB02-020J	1/4	14.3	10	7	22	59	36	32	1/4	M30×2	P18	0.26
WUB02-030J	1/4	14.3	10	9	22	60	36	32	3/8	M30×2	P18	0.27
WUB03-030J	3/8	17.8	10	9	27	62.5	41	41	3/8	M36×2	P20	0.39
◎ WUB03-040J	3/8	17.8	10	12	27	66.5	41	41	1/2	M36×2	P20	0.40
◎ WUB04-040J	1/2	22.2	10	12	32	70.5	46	41	1/2	M39×2	G25	0.49
◎ WUB04-060J	1/2	22.2	10	16	32	72.5	46	41	3/4	M39×2	G25	0.50
◎ WUB06-060J	3/4	27.7	13	16	38	80.5	55	50	3/4	M48×2	G30	0.84
◎ WUB06-080J	3/4	27.7	13	20	38	84.5	55	50	1	M48×2	G30	0.88
◎ WUB08-080J	1	34.5	13	20	47	88.5	65	60	1	M56×2	G35	1.24
◎ WUB08-100J	1	34.5	13	25	47	91.5	65	60	1 1/4	M56×2	G35	1.30
◎ WUB10-100J	1 1/4	43.2	13	25	58	99	80	70	1 1/4	M68×2	G45	2.07
◎ WUB10-120J	1 1/4	43.2	13	32	58	99	80	70	1 1/2	M68×2	G45	2.01
◎ WUB12-120J	1 1/2	49.1	13	32	63	108	85	75	1 1/2	M72×2	G50	2.51
◎ WUB12-160J	1 1/2	49.1	13	38	63	112	85	75	2	M72×2	G50	2.61
◎ WUB16-160J	2	61.1	16	38	81	114	104	95 (OCT)	2	M90×2	G65	3.93

◎略図中「A本体」P処理 / 「ABody」Parkerizing

本体材質: S45C / Body material: S45C

注) O-RingはJIS B2401-1Bです。定格圧力: 21MPa (210kgf/cm²)
使用温度: 120℃以下

炭素鋼以外は寸法が異なるので、都度お問い合わせください。(Jシリーズになります。)

Note: O-ring is JIS B2401-1B. Rated pressure: 21MPa (210kgf/cm²)

Operating temperature: Less than 120℃

Stainless steel products deviate from the above dimensions. (contact us)

ユニオンC形 WUC / Union Type C WUC

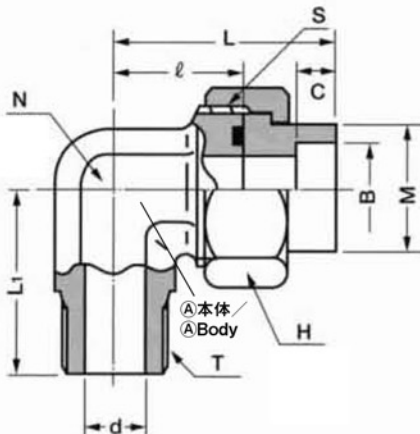

単位: mm / unit: mm

継手の呼び Part No.	呼び径 Nominal sizes	B	C	d	M	ℓ	L	L ₁	N	H (八角) H (OCT)	T (R)	S	O-Ring	重量 (kg) Weight (kg)
WUC02-020J	1/4	14.3	10	7	22	29	48	32	22	36	1/4	M30×2	P18	0.27
WUC02-030J	1/4	14.3	10	9	22	29	48	33	22	36	3/8	M30×2	P18	0.27
WUC03-030J	3/8	17.8	10	9	27	30	49.5	38	27	41	3/8	M36×2	P20	0.38
◎ WUC03-040J	3/8	17.8	10	12	27	30	49.5	40	27	41	1/2	M36×2	P20	0.39
◎ WUC04-040J	1/2	22.2	10	12	32	33	56.5	45	30	46	1/2	M39×2	G25	0.54
◎ WUC04-060J	1/2	22.2	10	16	32	33	56.5	47	30	46	3/4	M39×2	G25	0.55
◎ WUC06-060J	3/4	27.7	13	16	38	40	65.5	52	36	55	3/4	M48×2	G30	0.88
◎ WUC06-080J	3/4	27.7	13	20	38	40	65.5	54	36	55	1	M48×2	G30	0.90
◎ WUC08-080J	1	34.5	13	20	47	45	73.5	60	46	65	1	M56×2	G35	1.56
◎ WUC08-100J	1	34.5	13	25	47	45	73.5	63	46	65	1 1/4	M56×2	G35	1.60
◎ WUC10-100J	1 1/4	43.2	13	25	58	48	81	72	50	80	1 1/4	M68×2	G45	2.54
◎ WUC10-120J	1 1/4	43.2	13	32	58	48	81	72	50	80	1 1/2	M68×2	G45	2.44
◎ WUC12-120J	1 1/2	49.1	13	32	63	57	95	72	60	85	1 1/2	M72×2	G50	2.88
◎ WUC12-160J	1 1/2	49.1	13	38	63	60	98	82	65	85	2	M72×2	G50	2.96
◎ WUC16-160J	2	61.1	16	38	81	60	98	82	65	104	2	M90×2	G65	3.85

◎略図中「A本体」P処理 / 「ABody」Parkerizing

注) O-RingはJIS B2401-1Bです。定格圧力: 21MPa (210kgf/cm²)
使用温度: 120℃以下

ステンレス鋼についてはナットの形状は1^B(08)までは六角とします。

又、本体についても形状寸法が異なります。

炭素鋼以外は寸法が異なるので、都度お問い合わせください。(Jシリーズになります。)

Note: O-ring is JIS B2401-1B. Rated pressure: 21MPa (210kgf/cm²)

Operating temperature: Less than 120℃

For stainless steel, the nut configuration up to 1^B (08) is hex.

Also the configuration and dimension of the body are not the same.

Stainless steel products deviate from the above dimensions. (contact us)

WUD・WUH 差込み溶接形管継手 / Socket Weld Pipe Fittings

ユニオンD形 WUD / Union Type D WUD

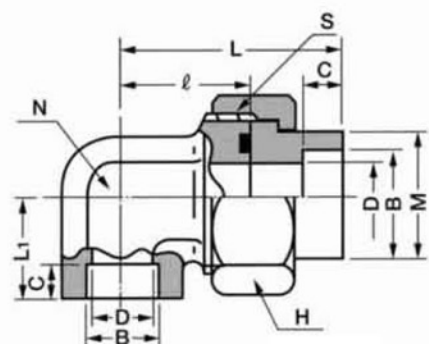

単位: mm / unit: mm

継手の呼び Part No.	呼び径 Nominal sizes	B	C	D	M	ℓ	L	L ₁	H(八角) H(OCT)	S	O-Ring	N	重量 (kg) Weight (kg)
WUD02-020J	1/4	14.3	10	9.4	22	30	49	21	36	M30×2	P18	22	0.26
WUD03-030J	3/8	17.8	10	12.7	27	32	51.5	24	41	M36×2	P20	27	0.37
WUD04-040J	1/2	22.2	10	16.1	32	34	57.5	26	46	M39×2	G25	32	0.51
WUD06-060J	3/4	27.7	13	21.4	38	41	66.5	32	55	M48×2	G30	36	0.82
WUD08-080J	1	34.5	13	27.2	47	46	74.5	35	65	M56×2	G35	41	1.25
WUD10-100J	1 1/4	43.2	13	35.5	58	50	83	40	80	M68×2	G45	50	1.97
WUD12-120J	1 1/2	49.1	13	41.2	63	58	96	45	85	M72×2	G50	60	2.65
WUD16-160J	2	61.1	16	52.7	81	64	102	55	104	M90×2	G65	70	3.94

注) O-RingはJIS B2401-1Bです。定格圧力:21MPa(210kgf/cm²)

使用温度:120℃以下
炭素鋼以外は寸法が異なるので、都度お問い合わせください。(Jシリーズになります。)
Note: O-ring is JIS B2401-1B. Rated pressure: 21MPa (210kgf/cm²)
Operating temperature: Less than 120℃
Stainless steel products deviate from the above dimensions. (contact us)

ユニオンH形 WUH / Union Type H WUH

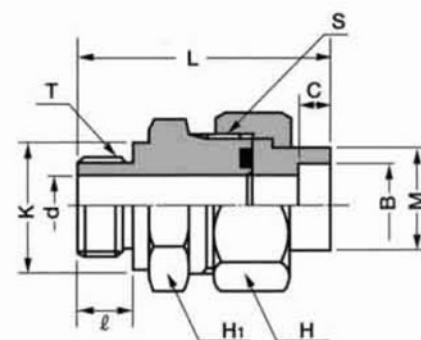

単位: mm / unit: mm

継手の呼び Part No.	呼び径 Nominal sizes	B	C	d	K	M	ℓ	L	H(八角) H(OCT)	H ₁ (六角) H ₁ (HEX)	T (G)	S	O-Ring Ring	重量 (kg) Weight (kg)
WUH02-030J	1/4	14.3	10	7	22	22	12	63	36	32	3/8	M30×2	P18	0.29
WUH03-040J	3/8	17.8	10	12	27	27	14	67	41	41	1/2	M36×2	P20	0.41
WUH04-060J	1/2	22.2	10	16	36	32	16	73	46	41	3/4	M39×2	G25	0.52
WUH06-080J	3/4	27.7	13	20	41	38	18	87	55	50	1	M48×2	G30	0.92
WUH08-100J	1	34.5	13	28	50	47	20	93	65	60	1 1/4	M56×2	G35	1.32
WUH10-120J	1 1/4	43.2	13	32	55	58	21	101	80	70	1 1/2	M68×2	G45	2.06
WUH12-160J	1 1/2	49.1	13	40	75	63	25	114	85	75	2	M72×2	G50	2.68
WUH16-160J	2	61.1	16	40	75	81	25	115	104	95	2	M90×2	G65	4.00

注) O-RingはJIS B2401-1Bです。定格圧力:21MPa(210kgf/cm²)

使用温度:120℃以下
炭素鋼以外は寸法が異なるので、都度お問い合わせください。(Jシリーズになります。)
Note: O-ring is JIS B2401-1B. Rated pressure: 21MPa (210kgf/cm²)
Operating temperature: Less than 120℃
Stainless steel products deviate from the above dimensions. (contact us)

本体材質:S45C / Body material: S45C

SUA・WUF

ねじ込み形管継手 / Threaded Pipe Fittings

ユニオン SUA / Union SUA

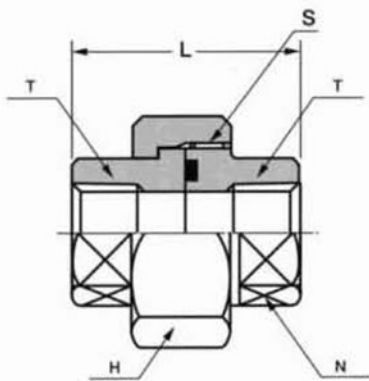

単位: mm / unit: mm

継手の呼び Part No.	T (Rc)	N (八角) N (OCT)	L	H (八角) H (OCT)	S	O-Ring	重量 (kg) Weight (kg)
SUA02-000J	1/4	20	39.5	36	M30×2	P18	0.17
SUA03-000J	3/8	24	41.5	41	M36×2	P20	0.23
SUA04-000J	1/2	29	49	46	M39×2	G25	0.33
SUA06-000J	3/4	35	55	55	M48×2	G30	0.54
SUA08-000J	1	44	59.5	65	M56×2	G35	0.80
SUA10-000J	1 1/4	54	67.5	80	M68×2	G45	1.34
SUA12-000J	1 1/2	60	79	85	M72×2	G50	1.74
SUA16-000J	2	75	82	104	M90×2	G65	2.55

注) O-RingはJIS B2401-1Bです。定格圧力:21MPa (210kgf/cm²)
 使用温度:120℃以下
 炭素鋼以外は寸法が異なるので、都度お問い合わせください。(Jシリーズになります。)
 Note: O-ring is JIS B2401-1B. Rated pressure: 21MPa (210kgf/cm²)
 Operating temperature: Less than 120℃
 Stainless steel products deviate from the above dimensions. (contact us)

ユニオンF形 WUF / Union Type F WUF

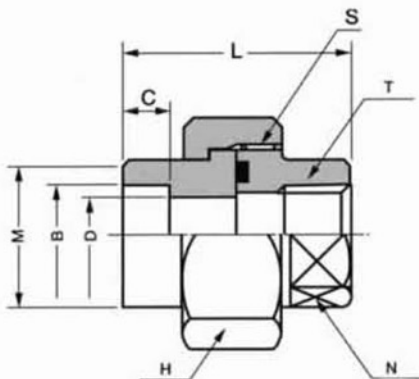

単位: mm / unit: mm

継手の呼び Part No.	呼び径 Nominal sizes	B	C	D	M	L	N(八角) N (OCT)	H(八角) H (OCT)	S	T (R)	O-Ring	重量 (kg) Weight (kg)
WUF02-020J	1/4	14.3	10	9.4	22	39	20	36	M30×2	1/4	P18	0.18
WUF03-030J	3/8	17.8	10	12.7	27	41	24	41	M36×2	3/8	P20	0.23
WUF04-040J	1/2	22.2	10	16.1	32	48	29	46	M39×2	1/2	G25	0.33
WUF06-060J	3/4	27.7	13	21.4	38	54	35	55	M48×2	3/4	G30	0.54
WUF08-080J	1	34.5	13	27.2	47	58.5	44	65	M56×2	1	G35	0.80
WUF10-100J	1 1/4	43.2	13	35.5	58	66.5	54	80	M68×2	1 1/4	G45	1.36
WUF12-120J	1 1/2	49.1	13	41.2	63	78	60	85	M72×2	1 1/2	G50	1.77
WUF16-160J	2	61.1	16	52.7	81	79	75	104	M90×2	2	G65	2.58

注) O-RingはJIS B2401-1Bです。定格圧力:21MPa (210kgf/cm²)
 使用温度:120℃以下
 炭素鋼以外は寸法が異なるので、都度お問い合わせください。(Jシリーズになります。)
 Note: O-ring is JIS B2401-1B. Rated pressure: 21MPa (210kgf/cm²)
 Operating temperature: Less than 120℃
 Stainless steel products deviate from the above dimensions. (contact us)

FA-A 油圧用21MPa管フランジ JIS B2291-1994準拠

Pipe Flange for 21MPa Hydraulic Use Based on JIS B2291-1994

油圧用21MPa管フランジ FA-A / Pipe Flange Assembly for 21MPa Hydraulic Use FA-A

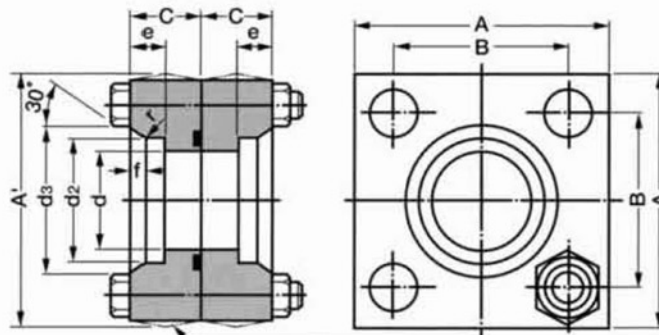
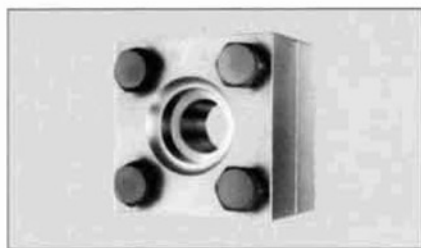

鍛造による場合の形状
Configuration by forging

FA-A形 / FA-A type

単位：mm/unit: mm

継手の呼び Part No.	対応する管の呼び Nominal sizes of matching tubes	A	最大A' Max A'	B	C	d	d ₂	d ₃	e	f	r	ボルト BOLT	O-Ring JIS B2401-B	重量 (kg) Weight (kg)
FA-A-10	3/8	63	67	40	22	11	17.8 ^{+0.2} ₀	28	11	3.5	5	M10× 55	G25	1.42
FA-A-15	1/2	63	67	40	22	16	22.2 ^{+0.2} ₀	32	11	3.5	5	M10× 55	G25	1.41
FA-A-20	3/4	68	72	45	22	20	27.7 ^{+0.2} ₀	38	12	4.0	5	M10× 55	G30	1.50
FA-A-25	1	80	85	53	28	25	34.5 ^{+0.3} ₀	45	14	4.0	5	M12× 70	G35	2.94
FA-A-32	1 1/4	90	95	63	28	31.5	43.2 ^{+0.3} ₀	56	16	6.0	5	M12× 70	G40	3.30
FA-A-40	1 1/2	100	106	70	36	37.5	49.1 ^{+0.3} ₀	63	18	7.0	5	M16× 90	G50	5.40
FA-A-50	2	112	118	80	36	47.5	61.1 ^{+0.3} ₀	75	20	7.0	5	M16× 90	G60	6.20
FA-A-65	2 1/2	140	148	100	45	60	77.1 ^{+0.4} ₀	95	22	9.5	6	M20×115	G75	12.40
FA-A-80	3	155	163	112	45	71	90.0 ^{+0.4} ₀	108	25	11.0	6	M22×115	G85	15.50

この表によるものは、FA-HA-(各種) (P.36) を一組としたもので、ボルトの強さは8Tであります。
FA-HB-(各種) (P.36)

This table shows when FA-HA-(all types)(P36) are as a set, and the bolt strength is 8T.
FA-HB-(all types)(P36)

注) 炭素鋼以外は寸法が異なるので、都度お問い合わせください。(Jシリーズになります。)
Note: Stainless steel products deviate from the above dimensions. (contact us)

FA-HA・FA-HB

油圧用21MPa管フランジ JIS B2291-1994準拠
Pipe Flange for 21MPa Hydraulic Use Based on JIS B2291-1994

油圧用21MPa管フランジ FA-HA・FA-HB / Pipe Flange for 21MPa Hydraulic Use FA-HA・FA-HB

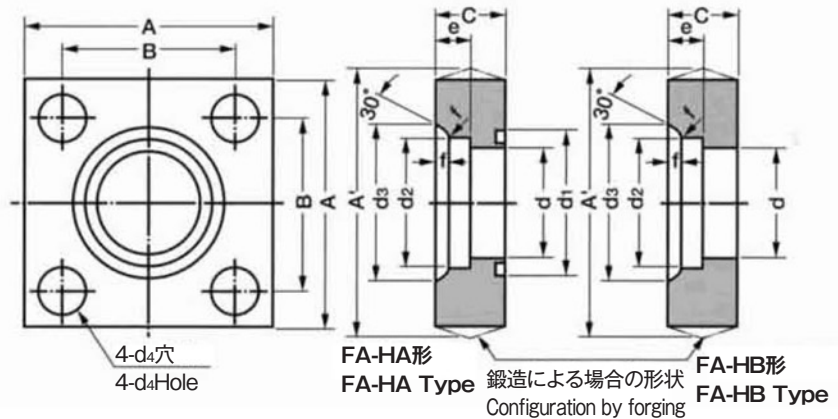

FA-HA形 / FA-HA type

単位：mm / unit: mm

継手の呼び Part No.	相当するJISの呼び方 Equivalent JIS description	対応する 管の呼び Nominal sizes of matching tubes	A	最大A' Max A'	B	C	d	d ₁	d ₂	d ₃	d ₄	e	f	r	参考 / Reference	
															ボルト BOLT	O-Ring
FA-HA-10		3/8	63	67	40	22	11	30	17.8 ^{+0.2} ₀	28	11	11	3.5	5	M10	G25
FA-HA-15	SHA15	1/2	63	67	40	22	16	30	22.2 ^{+0.2} ₀	32	11	11	3.5	5	M10	G25
FA-HA-20	SHA20	3/4	68	72	45	22	20	35	27.7 ^{+0.2} ₀	38	11	12	4.0	5	M10	G30
FA-HA-25	SHA25	1	80	85	53	28	25	40	34.5 ^{+0.3} ₀	45	13	14	4.0	5	M12	G35
FA-HA-32	SHA32	1 1/4	90	95	63	28	31.5	45	43.2 ^{+0.3} ₀	56	13	16	6.0	5	M12	G40
FA-HA-40	SHA40	1 1/2	100	106	70	36	37.5	55	49.1 ^{+0.3} ₀	63	18	18	7.0	5	M16	G50
FA-HA-50	SHA50	2	112	118	80	36	47.5	65	61.1 ^{+0.3} ₀	75	18	20	7.0	5	M16	G60
FA-HA-65	SHA65	2 1/2	140	148	100	45	60	80	77.1 ^{+0.4} ₀	95	22	22	9.5	6	M20	G75
FA-HA-80	SHA80	3	155	163	112	45	71	90	90.0 ^{+0.4} ₀	108	24	25	11.0	6	M22	G85

FA-HB形 / FA-HB type

単位：mm / unit: mm

継手の呼び Part No.	相当するJISの呼び方 Equivalent JIS description	対応する 管の呼び Nominal sizes of matching tubes	A	最大A' Max A'	B	C	d	d ₂	d ₃	d ₄	e	f	r	参考 / Reference	
														ボルト BOLT	O-Ring
FA-HB-10		3/8	63	67	40	22	11	17.8 ^{+0.2} ₀	28	11	11	3.5	5	M10	G25
FA-HB-15	SHB15	1/2	63	67	40	22	16	22.2 ^{+0.2} ₀	32	11	11	3.5	5	M10	G25
FA-HB-20	SHB20	3/4	68	72	45	22	20	27.7 ^{+0.2} ₀	38	11	12	4.0	5	M10	G30
FA-HB-25	SHB25	1	80	85	53	28	25	34.5 ^{+0.3} ₀	45	13	14	4.0	5	M12	G35
FA-HB-32	SHB32	1 1/4	90	95	63	28	31.5	43.2 ^{+0.3} ₀	56	13	16	6.0	5	M12	G40
FA-HB-40	SHB40	1 1/2	100	106	70	36	37.5	49.1 ^{+0.3} ₀	63	18	18	7.0	5	M16	G50
FA-HB-50	SHB50	2	112	118	80	36	47.5	61.1 ^{+0.3} ₀	75	18	20	7.0	5	M16	G60
FA-HB-65	SHB65	2 1/2	140	148	100	45	60	77.1 ^{+0.4} ₀	95	22	22	9.5	6	M20	G75
FA-HB-80	SHB80	3	155	163	112	45	71	90.0 ^{+0.4} ₀	108	24	25	11.0	6	M22	G85

この表によるものは単体で取り扱い、参考として示したボルト及びO-Ringは標準付属いたしません。
Items of this table are to be treated as individual items, and the bolts and O-Ring Listed as reference are not included as standard accessories.

注) 炭素鋼以外は寸法が異なるので、都度お問い合わせください。(Jシリーズになります。)
Note: Stainless steel products deviate from the above dimensions. (contact us)

FA-SA・FA-SB

油圧用21MPa管フランジ JIS B2291-1994準拠
Pipe Flange for 21MPa Hydraulic Use Based on JIS B2291-1994

油圧用21MPa管フランジ FA-SA・FA-SB / Pipe Flange for 21MPa Hydraulic Use FA-SA・FA-SB

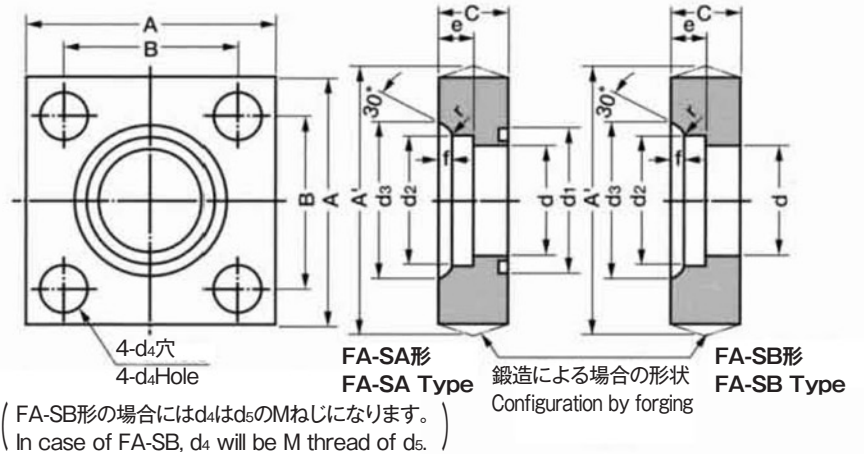
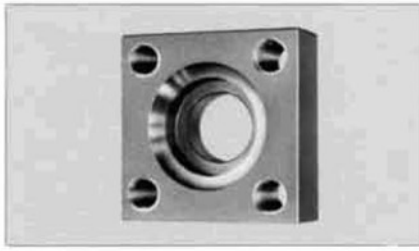

FA-SA形 / FA-SA type

単位：mm/unit: mm

継手の呼び Part No.	相当するJISの呼び方 Equivalent JIS description	対応する 管の呼び Nominal Sizes of matching tubes	A	最大A' Max A'	B	C	d	d ₁	d ₂	d ₃	d ₄	e	f	r	参考 / Reference	
															ボルト BOLT	O-Ring
FA-SA-10		3/8	54	58	36	22	11	30	17.8 ^{+0.2} ₀	28	11	11	3.5	5	M10	G25
FA-SA-15	SSA15	1/2	54	58	36	22	16	30	22.2 ^{+0.2} ₀	32	11	11	3.5	5	M10	G25
FA-SA-20	SSA20	3/4	58	62	40	22	20	35	27.7 ^{+0.2} ₀	38	11	12	4.0	5	M10	G30
FA-SA-25	SSA25	1	68	73	48	28	25	40	34.5 ^{+0.3} ₀	45	13	14	4.0	5	M12	G35
FA-SA-32	SSA32	1 1/4	76	81	56	28	31.5	45	43.2 ^{+0.3} ₀	56	13	16	6.0	5	M12	G40
FA-SA-40	SSA40	1 1/2	92	98	65	36	37.5	55	49.1 ^{+0.3} ₀	63	18	18	7.0	5	M16	G50
FA-SA-50	SSA50	2	100	106	73	36	47.5	65	61.1 ^{+0.3} ₀	75	18	20	7.0	5	M16	G60
FA-SA-65	SSA65	2 1/2	128	136	92	45	60	80	77.1 ^{+0.4} ₀	95	22	22	9.5	6	M20	G75
FA-SA-80	SSA80	3	140	148	103	45	71	90	90.0 ^{+0.4} ₀	108	24	25	11.0	6	M22	G85

FA-SB形 / FA-SB type

単位：mm/unit: mm

継手の呼び Part No.	相当するJISの呼び方 Equivalent JIS description	対応する 管の呼び Nominal Sizes of matching tubes	A	最大A' Max A'	B	C	d	d ₂	d ₃	e	d ₅	f	r	参考 / Reference	
														ボルト BOLT	O-Ring
FA-SB-10		3/8	54	58	36	22	11	17.8 ^{+0.2} ₀	28	11	M10×1.5	3.5	5	M10	G25
FA-SB-15	SSB15	1/2	54	58	36	22	16	22.2 ^{+0.2} ₀	32	11	M10×1.5	3.5	5	M10	G25
FA-SB-20	SSB20	3/4	58	62	40	22	20	27.7 ^{+0.2} ₀	38	12	M10×1.5	4.0	5	M10	G30
FA-SB-25	SSB25	1	68	73	48	28	25	34.5 ^{+0.3} ₀	45	14	M12×1.75	4.0	5	M12	G35
FA-SB-32	SSB32	1 1/4	76	81	56	28	31.5	43.2 ^{+0.3} ₀	56	16	M12×1.75	6.0	5	M12	G40
FA-SB-40	SSB40	1 1/2	92	98	65	36	37.5	49.1 ^{+0.3} ₀	63	18	M16×2	7.0	5	M16	G50
FA-SB-50	SSB50	2	100	106	73	36	47.5	61.1 ^{+0.3} ₀	75	20	M16×2	7.0	5	M16	G60
FA-SB-65	SSB65	2 1/2	128	136	92	45	60	77.1 ^{+0.4} ₀	95	22	M20×2.5	9.5	6	M20	G75
FA-SB-80	SSB80	3	140	148	103	45	71	90.0 ^{+0.4} ₀	108	25	M22×2.5	11.0	6	M22	G85

この表によるものは単体で取り扱い、参考として示したボルト及びO-Ringは標準付属いたしません。
Items of this table are to be treated as individual items, and the bolts and O-Ring Listed as reference are not included as standard accessories.

注) 炭素鋼以外は寸法が異なるので、都度お問い合わせください。(Jシリーズになります。)
Note: Stainless steel products deviate from the above dimensions. (contact us)

FA-LA 油圧用21MPa管フランジ JIS B2291-1994準拠

Pipe Flange for 21MPa Hydraulic Use Based on JIS B2291-1994

油圧用21MPa管フランジ FA-LA / Pipe Flange for 21MPa Hydraulic Use FA-LA

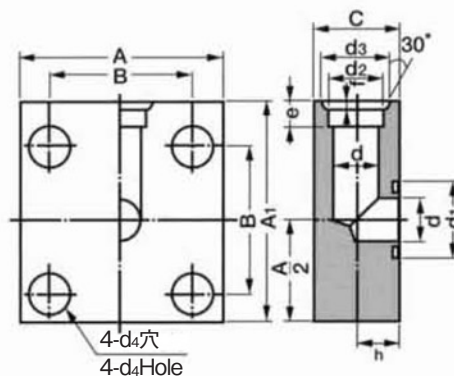
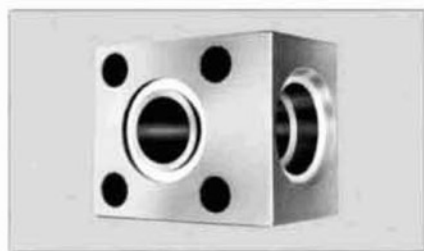

FA-LA形 / FA-LA type

単位：mm / unit: mm

継手の呼び Part No.	相当するJISの呼び方 Equivalent JIS description	対応する 管の呼び Nominal sizes of matching tubes	A	A ₁	B	C	h	d	d ₁	d ₂	d ₃	d ₄	e	f	r	参考 / Reference	
																ボルト BOLT	O-Ring
FA-LA-10		3/8	54	63	36	40	20	11	30	17.8 ^{+0.2} ₀	28	11	11	3.5	5	M10	G25
FA-LA-15	LSA15	1/2	54	63	36	40	20	16	30	22.2 ^{+0.2} ₀	32	11	11	3.5	5	M10	G25
FA-LA-20	LSA20	3/4	58	70	40	45	22.5	20	35	27.7 ^{+0.2} ₀	38	11	12	4.0	5	M10	G30
FA-LA-25	LSA25	1	68	82	48	50	25	25	40	34.5 ^{+0.3} ₀	45	13	14	4.0	5	M12	G35
FA-LA-32	LSA32	1 1/4	76	92	56	63	31.5	31.5	45	43.2 ^{+0.3} ₀	56	13	16	6.0	5	M12	G40
FA-LA-40	LSA40	1 1/2	92	110	65	71	35.5	37.5	55	49.1 ^{+0.3} ₀	63	18	18	7.0	5	M16	G50
FA-LA-50	LSA50	2	100	125	73	85	42.5	47.5	65	61.1 ^{+0.3} ₀	75	18	20	7.0	5	M16	G60
FA-LA-65	LSA65	2 1/2	128	150	92	106	53	60	80	77.1 ^{+0.4} ₀	95	22	22	9.5	6	M20	G75
FA-LA-80	LSA80	3	140	170	103	118	59	71	90	90.0 ^{+0.4} ₀	108	24	25	11.0	6	M22	G85

この表によるものは単体で取り扱い、参考として示したボルト及びO-Ringは標準付属いたしません。
Items of this table are to be treated as individual items, and the bolts and O-Ring Listed as reference are not included as standard accessories.

注) 炭素鋼以外は寸法が異なるので、都度お問い合わせください。(Jシリーズになります。)
Note: Stainless steel products deviate from the above dimensions. (contact us)

FA-YA・FA-YB 油圧用280K管フランジ JIS F7806-1996準拠

Pipe Flange for 280K Hydraulic Use Based on JIS F7806-1996

油圧用280K管フランジ FA-YA・FA-YB / Pipe Flange for 280K Hydraulic Use FA-YA・FA-YB

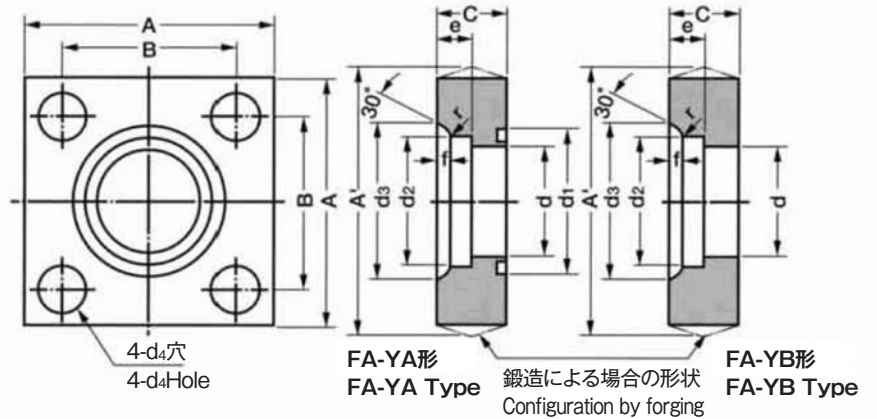
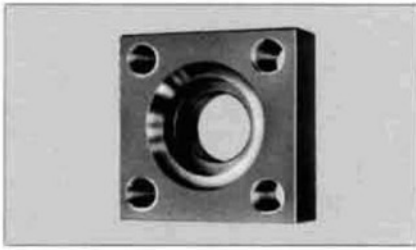

FA-YA形 / FA-YA type

単位：mm/unit: mm

継手の呼び Part No.	相当するJISの呼び方 Equivalent JIS description	対応する 管の呼び Nominal Sizes of matching tubes	A	最大A' Max A'	B	C	d	d ₁	d ₂	d ₃	d ₄	e	f	r	参考 / Reference		重量 (kg) Weight (kg)
															ボルト BOLT	O-Ring	
FA-YA15	280KA15	1/2	66	70	43	22	12.3	24	22.2 ^{+0.2} ₀	34	11	12	4.0	5	M10	P20	0.63
FA-YA20	280KA20	3/4	72	76	48	25	16.2	30	27.7 ^{+0.2} ₀	40	11	12	4.5	5	M10	G25	0.85
FA-YA25	280KA25	1	85	91	58	35	21.2	35	34.5 ^{+0.3} ₀	48	13.5	14	5.0	5	M12	G30	1.64
FA-YA32	280KA32	1 1/4	98	104	68	35	29.9	45	43.2 ^{+0.3} ₀	60	17.5	18	6.5	5	M16	G40	2.03
FA-YA40	280KA40	1 1/2	105	112	74	40	34.4	50	49.1 ^{+0.3} ₀	66	17.5	20	7.5	5	M16	G45	2.66
FA-YA50	280KA50	2	130	139	90	50	43.1	60	61.1 ^{+0.3} ₀	79	22	20	8.0	5	M20	G55	5.14
FA-YA65	280KA65	2 1/2	150	161	108	60	57.3	75	77.1 ^{+0.4} ₀	100	24	25	10.0	6	M22	G70	7.95
FA-YA80	280KA80	3	170	181	120	65	66.9	85	90.0 ^{+0.4} ₀	114	26	25	12.0	6	M24	G80	11.00

FA-YB形 / FA-YB type

単位：mm/unit: mm

継手の呼び Part No.	相当するJISの呼び方 Equivalent JIS description	対応する 管の呼び Nominal Sizes of matching tubes	A	最大A' Max A'	B	C	d	d ₂	d ₃	d ₄	e	f	r	参考 / Reference		重量 (kg) Weight (kg)
														ボルト BOLT	O-Ring	
FA-YB15	280KB15	1/2	66	70	43	22	12.3	22.2 ^{+0.2} ₀	34	11	12	4.0	5	M10	P20	0.63
FA-YB20	280KB20	3/4	72	76	48	25	16.2	27.7 ^{+0.2} ₀	40	11	12	4.0	5	M10	G25	0.85
FA-YB25	280KB25	1	85	91	58	35	21.2	34.5 ^{+0.3} ₀	48	13.5	14	5.0	5	M12	G30	1.64
FA-YB32	280KB32	1 1/4	98	104	68	35	29.9	43.2 ^{+0.3} ₀	60	17.5	18	6.5	5	M16	G40	2.03
FA-YB40	280KB40	1 1/2	105	112	74	40	34.4	49.1 ^{+0.3} ₀	66	17.5	20	7.5	5	M16	G45	2.66
FA-YB50	280KB50	2	130	139	90	50	43.1	61.1 ^{+0.3} ₀	79	22	20	8.0	5	M20	G55	5.14
FA-YB65	280KB65	2 1/2	150	161	108	60	57.3	77.1 ^{+0.4} ₀	100	24	25	10.0	6	M22	G70	7.95
FA-YB80	280KB80	3	170	181	120	65	66.9	90.0 ^{+0.4} ₀	114	26	25	12.0	6	M24	G80	11.00

この表によるものは単体で取り扱い、参考として示したボルト及びO-Ringは標準付属いたしません。
Items of this table are to be treated as individual items, and the bolts and O-Ring Listed as reference are not included as standard accessories.

注) 炭素鋼以外は寸法が異なるので、都度お問い合わせください。(Jシリーズになります)
Note: Stainless steel products deviate from the above dimensions. (contact us)

FA-ZA・FA-ZB

油圧用350K管フランジ JIS F7806-1996準拠

Pipe Flange for 350K Hydraulic Use Based on JIS F7806-1996

油圧用350K管フランジ FA-ZA・FA-ZB / Pipe Flange for 350K Hydraulic Use FA-ZA・FA-ZB

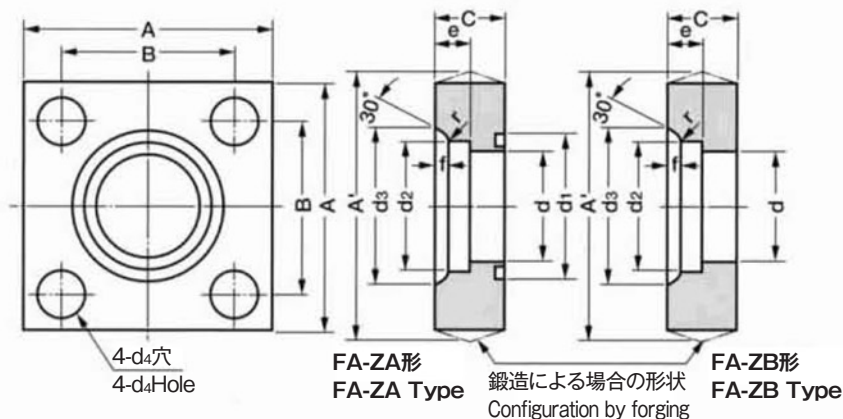
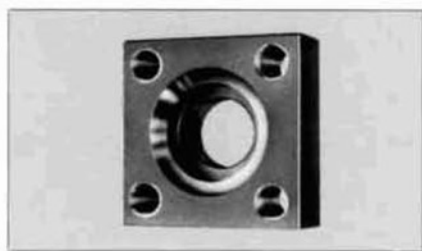

FA-ZA形 / FA-ZA type

単位：mm / unit: mm

継手の呼び Part No.	相当するJISの呼び方 Equivalent JIS description	対応する 管の呼び Nominal sizes of matching tubes	A	最大A' Max A'	B	C	d	d ₁	d ₂	d ₃	d ₄	e	f	r	参考 / Reference		重量 (kg) Weight (kg)
															ボルト BOLT	O-Ring	
FA-ZA-15	350KA15	1/2	68	73	45	28	12.3	24	22.2 ^{+0.2} ₀	37.5	11	12	4	5	M10	P20	0.88
FA-ZA-20	350KA20	3/4	82	87	55	30	16.2	30	27.7 ^{+0.2} ₀	43.5	13.5	12	5	5	M12	G25	1.34
FA-ZA-25	350KA25	1	95	101	65	35	21.2	35	34.5 ^{+0.3} ₀	53	17.5	14	5.5	6	M16	G30	2.02
FA-ZA-32	350KA32	1 1/4	100	106	70	35	23.3	40	43.2 ^{+0.3} ₀	63	17.5	18	7	6	M16	G35	2.16
FA-ZA-40	350KA40	1 1/2	105	112	75	42	28.2	45	49.1 ^{+0.3} ₀	70	17.5	20	8	6	M16	G40	2.84
FA-ZA-50	350KA50	2	132	140	92	50	38.3	55	61.1 ^{+0.3} ₀	84	22	25	9	6	M20	G50	5.30
FA-ZA-65	350KA65	2 1/2	160	170	112	60	48.3	65	77.1 ^{+0.4} ₀	105	26	30	12	7	M24	G60	9.92
FA-ZA-80	350KA80	3	190	202	130	68	58.7	75	90.0 ^{+0.4} ₀	120	33	30	13.5	7	M30	G70	14.80

FA-ZB形 / FA-ZB type

単位：mm / unit: mm

継手の呼び Part No.	相当するJISの呼び方 Equivalent JIS description	対応する 管の呼び Nominal sizes of matching tubes	A	最大A' Max A'	B	C	d	d ₂	d ₃	d ₄	e	f	r	参考 / Reference		重量 (kg) Weight (kg)
														ボルト BOLT	O-Ring	
FA-ZB-15	350KB15	1/2	68	73	45	28	12.3	22.2 ^{+0.2} ₀	37.5	11	12	4	5	M10	P20	0.88
FA-ZB-20	350KB20	3/4	82	87	55	30	16.2	27.7 ^{+0.2} ₀	43.5	13.5	12	5	5	M12	G25	1.34
FA-ZB-25	350KB25	1	95	101	65	35	21.2	34.5 ^{+0.3} ₀	53	17.5	14	5.5	6	M16	G30	2.02
FA-ZB-32	350KB32	1 1/4	100	106	70	35	23.3	43.2 ^{+0.3} ₀	63	17.5	18	7	6	M16	G35	2.16
FA-ZB-40	350KB40	1 1/2	105	112	75	42	28.2	49.1 ^{+0.3} ₀	70	17.5	20	8	6	M16	G40	2.84
FA-ZB-50	350KB50	2	132	140	92	50	38.3	61.1 ^{+0.3} ₀	84	22	25	9	6	M20	G50	5.30
FA-ZB-65	350KB65	2 1/2	160	170	112	60	48.3	77.1 ^{+0.4} ₀	105	26	30	12	7	M24	G60	9.92
FA-ZB-80	350KB80	3	190	202	130	68	58.7	90.0 ^{+0.4} ₀	120	33	30	13.5	7	M30	G70	14.80

この表によるものは単体で取り扱い、参考として示したボルト及びO-Ringは標準付属いたしません。

Items of this table are to be treated as individual items, and the bolts and O-Ring Listed as reference are not included as standard accessories.

注) 炭素鋼以外は寸法が異なるので、都度お問い合わせください。(Jシリーズになります。)

Note: Stainless steel products deviate from the above dimensions. (contact us)

FA-WA・FA-WB

油圧用35MPa(350kgf/cm²)突合せ溶接式管フランジ FAS 103-1996準拠
Butt Welding Type Pipe Flange for 35MPa (350kgf/cm²)
Hydraulic Use Based on FAS 103-1996

油圧用35MPa管フランジ FA-WA・FA-WB / Pipe Flange for 35MPa (350kgf/cm²) Hydraulic Use FA-WA・FA-WB

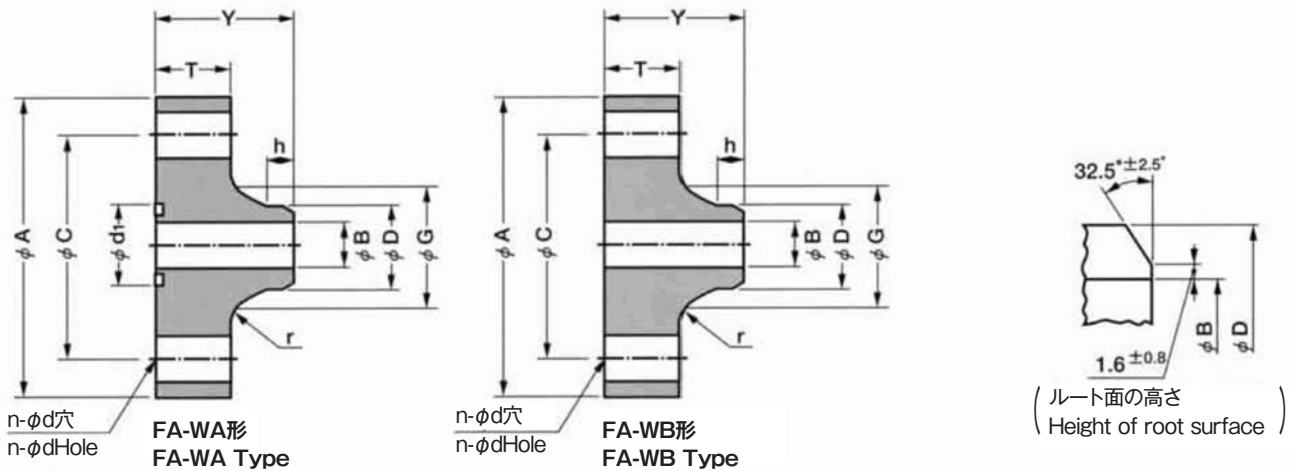

FA-WA形 / FA-WA type

単位：mm/unit: mm

継手の呼び Part No.	相当するJISの呼び方 Equivalent JIS description	対応する 管の呼び Nominal sizes of matching tubes	A	B ^{-0.5}	C	D ⁺¹	G	T	h	Y	r	n-d	d ₁	参考 / Reference		重量 (kg) Weight (kg)
														ボルト BOLT	O-Ring	
FA-WA-15	BWA15	1/2	90	12.3	63	21.7	32	25	7	43	5	4-13	24	M12	P20	1.25
FA-WA-20	BWA20	3/4	98	16.2	71	27.2	40	25	9	47	5	4-13	30	M12	G25	1.51
FA-WA-25	BWA25	1	120	21.2	88	34.0	48	30	10	55	6	4-18	35	M16	G30	2.73
FA-WA-32	BWA32	1 1/4	135	23.3	103	42.7	63	30	15	66	6	4-18	40	M16	G35	3.69
FA-WA-40	BWA40	1 1/2	145	28.2	113	48.6	73	35	16	77	6	4-18	45	M16	G40	5.00
FA-WA-50	BWA50	2	175	38.3	135	60.5	88	40	17	88	6	4-22	55	M20	G50	8.19
FA-WA-65	BWA65	2 1/2	185	48.3	150	76.3	108	45	21	101	7	8-18	65	M16	G60	10.65
FA-WA-80	BWA80	3	215	58.7	175	89.1	127	50	23	115	7	8-22	75	M20	G70	16.00

FA-WB形 / FA-WB type

単位：mm/unit: mm

継手の呼び Part No.	相当するJISの呼び方 Equivalent JIS description	対応する 管の呼び Nominal sizes of matching tubes	A	B ^{-0.5}	C	D ⁺¹	G	T	h	Y	r	n-d	参考 / Reference		重量 (kg) Weight (kg)
													ボルト BOLT	O-Ring	
FA-WB-15	BWB15	1/2	90	12.3	63	21.7	32	25	7	43	5	4-13	M12	P20	1.25
FA-WB-20	BWB20	3/4	98	16.2	71	27.2	40	25	9	47	5	4-13	M12	G25	1.51
FA-WB-25	BWB25	1	120	21.2	88	34.0	48	30	10	55	6	4-18	M16	G30	2.73
FA-WB-32	BWB32	1 1/4	135	23.3	103	42.7	63	30	15	66	6	4-18	M16	G35	3.69
FA-WB-40	BWB40	1 1/2	145	28.2	113	48.6	73	35	16	77	6	4-18	M16	G40	5.00
FA-WB-50	BWB50	2	175	38.3	135	60.5	88	40	17	88	6	4-22	M20	G50	8.19
FA-WB-65	BWB65	2 1/2	185	48.3	150	76.3	108	45	21	101	7	8-18	M16	G60	10.65
FA-WB-80	BWB80	3	215	58.7	175	89.1	127	50	23	115	7	8-22	M20	G70	16.00

この表によるものは単体で取り扱い、参考として示したボルト及びO-Ringは標準付属いたしません。
Items of this table are to be treated as individual items, and the bolts and O-Ring Listed as reference are not included as standard accessories.

注) 炭素鋼以外は寸法が異なるので、都度お問い合わせください。(Jシリーズになります)
Note: Stainless steel products deviate from the above dimensions. (contact us)

管継手の主要材料表と材料記号

LIST OF MAIN MATERIAL AND MATERIAL SYMBOLS FOR TUBE FITTINGS

管継手の主要材料表/List of Main Material for Tube Fittings

区分 Division	該当するJISの鋼管 Applicable JIS steel tubes	管継手の材質 Tube fittings material	管継手の材料記号 Tube fittings material symbols	化学成分% / Chemical composition %					
				C	Si	Mn	P	S	Ni
炭素鋼 Carbon steel	STPG370.410	S25C	※1) PT410	0.22~0.28	0.15~0.35	0.30~0.60	0.030 or Less	0.035 or Less	
	STS370.410	※2) ASTM A105		*0.25 or Less	0.35 or Less	*0.60~1.00	0.040 or Less	0.050 or Less	—
	STPT370.410	SGD4K	—	0.20~0.25	0.35 or Less	0.30~0.60	0.045 or Less	0.045 or Less	—
合金鋼 Alloy steel	STPA12	ASTM A182-F1	PA12	0.28 or Less	0.15~0.35	0.60~0.90	0.045 or Less	0.045 or Less	—
	STPA23	ASTM A182-F11	PA23	0.10~0.20	0.50~1.00	0.30~0.80	0.040 or Less	0.040 or Less	—
	STPA24	ASTM A182-F22	PA24	0.15 or Less	0.50 or Less	0.30~0.60	0.040 or Less	0.040 or Less	—
	STPA25	ASTM A182-F5	PA25	0.15 or Less	0.50 or Less	0.30~0.60	0.030 or Less	0.030 or Less	0.50 or Less
ステンレス鋼 Stainless steel	SUS304TP	JISG4303 SUS304	SUS304	0.08 or Less	1.00 or Less	2.00 or Less	0.045 or Less	0.030 or Less	8.00~10.50
	SUS304LTP	SUS304L	SUS304L	0.030 or Less	1.00 or Less	2.00 or Less	0.045 or Less	0.030 or Less	9.00~13.00
	SUS316TP	SUS316	SUS316	0.08 or Less	1.00 or Less	2.00 or Less	0.045 or Less	0.030 or Less	10.00~14.00
	SUS316LTP	SUS316L	SUS316L	0.30 or Less	1.00 or Less	2.00 or Less	0.045 or Less	0.030 or Less	12.00~15.00
	SUS321	SUS321	SUS321	0.08 or Less	1.00 or Less	2.00 or Less	0.045 or Less	0.030 or Less	9.00~13.00
低温用鋼 Low temperature steel	STPL380	ASTM A350-LF2	PL380	0.30 or Less	0.15~0.30	1.35 or Less	0.035 or Less	0.040 or Less	—
	STPL450	ASTM A350-LF3	PL450	0.20 or Less	0.20~0.35	0.90 or Less	0.035 or Less	0.040 or Less	3.25~3.75

化学成分% / Chemical composition %					機械的性質 / Mechanical Properties				
Cr	Mo	Cu	Ni	その他 Others	耐力又は降伏点 Yield Strength N/mm ²	引張強さ Tensile Strength N/mm ²	伸び Elongation %	絞り Reduction of Area %	硬さHB Hardness HB
					—	—	27 or Over		
—	—	—	—	—	—	—	24 or Over	—	—
—	—	—	—	—	—	—	—	—	—
—	0.44~0.65	—	—	—	—	—	20.0 or Over	30.0 or Over	143~192
1.00~1.50	0.44~0.65	—	—	—	—	—	20.0 or Over	30.0 or Over	143~207
2.00~2.50	0.87~1.13	—	—	—	—	—	20.0 or Over	30.0 or Over	156~207
4.0 ~ 6.0	0.44~0.65	—	—	—	—	—	20.0 or Over	35.0 or Over	143~217
18.00~20.00	—	—	—	—	205 or Over	520 or Over	40 or Over	60 or Over	187 or Less
18.00~20.00	—	—	—	—	175 or Over	480 or Over	40 or Over	60 or Over	187 or Less
16.00~18.00	2.00~3.00	—	—	—	205 or Over	520 or Over	40 or Over	60 or Over	187 or Less
16.00~18.00	2.00~3.00	—	—	—	175 or Over	480 or Over	40 or Over	60 or Over	187 or Less
17.00~18.00	—	—	—	Ti 5XC% or Over	205 or Over	520 or Over	40 or Over	50 or Over	187 or Less
—	—	—	—	—	—	—	22 or Over	30 or Over	197 or Less
—	—	—	—	—	—	—	22 or Over	35 or Over	197 or Less

※1) PT410については、JIS B8243(压力容器の構造)及び高圧ガス取締法の技術基準(告示第350号)を適用する場合にはS25Cとご指定ください。

※2) ※印の化学成分及び機械的性質は社内基準でASTM規格とは若干異なります。

※1) In regards 10 PT410, it is requested that S25C is specified in case JIS B8243 (construction of pressure vessel) and technical standard for high pressure gas regulation (Notice No.350) should apply.

※2) Chemical composition of marked※ is based on IHARA's original standard and slight different from ASTM Standard.

管継手の主要材料表と材料記号

LIST OF MAIN MATERIAL AND MATERIAL SYMBOLS FOR TUBE FITTINGS

材料による種類の記号及び対応する鋼管 / Type symbols by material and corresponding steel tubes

区分 / Division	材料による種類の記号 / Type symbol by material	対応する鋼管 / Corresponding steel tubes	摘要 / Application	
炭素鋼 Carbon steel	PS370	STPG370 of JIS G3454 STPG370 of JIS G3455	圧力配管用 For pressurized piping	
	PS410	STPG410 of JIS G3454 STPG410 of JIS G3455		
	PS480	STPG480 of JIS G3455		
	炭素鋼 Carbon steel	PT370	STPG370 of JIS G3454 STPG370 of JIS G3456	高温配管用 For high temperature piping
		PT410	STPG410 of JIS G3454 STPG410 of JIS G3456	
		PT480	STPG480 of JIS G3456	
	合金鋼 Alloy steel	PL380	STPL380 of JIS G3460	低温配管用 For low temperature piping
PA12		STPA12 of JIS G3458	高温配管用 For high temperature piping	
PA22		STPA22 of JIS G3458		
PA23		STPA23 of JIS G3458		
PA24		STPA24 of JIS G3458		
PA25		STPA25 of JIS G3458		
PA26		STPA26 of JIS G3458		
合金鋼 Alloy steel	PL450	STPL450 of JIS G3460	低温配管用 For low temperature piping	
	PL690	STPL690 of JIS G3460	低温配管用 For low temperature piping	
ステンレス鋼 Stainless steel	SUS304	SUS304TP of JIS G3459	耐食及び高温配管用 SUS329J1、SUS329J3L、 SUS329J4L、SUS405及びSUS430を 除き、低温配管用としても使用できる。 For corrosion resistance and high temperature piping. Can be used for low temperature piping except SUS329J1, SUS329J3L, SUS329J4L, and SUS405	
	SUS304H	SUS304HTP of JIS G3459		
	SUS304L	SUS304LTP of JIS G3459		
	SUS309S	SUS309STP of JIS G3459		
	SUS310	SUS310TP of JIS G3459		
	SUS310S	SUS310STP of JIS G3459		
	SUS316	SUS316TP of JIS G3459		
	SUS316H	SUS316HTP of JIS G3459		
	SUS316L	SUS316LTP of JIS G3459		
	SUS316Ti	SUS316TiTP of JIS G3459		
	SUS317	SUS317TP of JIS G3459		
	SUS317L	SUS317LTP of JIS G3459		
	SUS321	SUS321TP of JIS G3459		
	SUS321H	SUS321HTP of JIS G3459		
	SUS347	SUS347TP of JIS G3459		
	SUS347H	SUS347HTP of JIS G3459		
	SUS836L	SUS836LTP of JIS G3459		
	SUS890L	SUS890LTP of JIS G3459		
	SUS329J1	SUS329J1TP of JIS G3459		
	SUS329J3L	SUS329J3LTP of JIS G3459		
SUS329J4L	SUS329J4LTP of JIS G3459			
SUS405	SUS405TP of JIS G3459			
SUS430	SUS430TP of JIS G3459			

関連材料対比表
COMPARISON TABLE OF RELATED MATERIAL

この対比表による各種材質は同一ではなく、類似を意味します。

The material of this comparison table are not identical but indicate equivalent material.

区分 Division	鋼種 Steel	JIS規格 Type of JIS standard		ASTM規格 ASTM standard		
		鋼管 Steel tube	管継手 材料記号 Tube fitting material symbols	鍛造材 Forged material	鋼管 Steel tube	鋼板 Steel Plate
炭素鋼 Carbon steel	普通炭素鋼 Common carbon steel	SGP	—	A668-A	A53-F	A283-A
	Siキルド炭素鋼 Si killed carbon steel	STPT370	WPA	A105	A106-GrA	A283-GrA
		STPT410	WPB	A105	A106-GrB	A515-65,70
		STPT480	WPC	—	A106-GrC	—
合金鋼 Alloy steel	½Mo鋼 1/2 Mo steel	STPA12	WP1	A182-F1	A335-P1	A204-GrB
	1Cr-½ Mo鋼 1Cr-1/2 Mo steel	STPA22	WP12	A182-F12	A335-P12	A387-GrB
	1¼Cr-½ Mo鋼 1-1/4Cr-1/2 Mo steel	STPA23	WP11	A182-F11	A335-P11	A387-GrC
	2¼Cr-1 Mo鋼 2-1/4Cr-1 Mo steel	STPA24	WP22	A182-F22	A335-P22	A387-GrD
	5Cr-½ Mo鋼 5Cr-1/2 Mo steel	STPA25	WP5	A182-F5	A335-P5	A357
	9Cr-1 Mo鋼 9Cr-1 Mo steel	STPA26	WP9	A182-F9	A335-P9	—
低温用鋼 Low temperature steel	A \emptyset キルド鋼 A \emptyset killed steel	STPL380	WPL6	A350-LF2	A333-6	A516-60
	3½ Ni鋼 3-1/2 Ni steel	STPL450	WPL3	A350-LF3	A333-3	A203-D
ステンレス鋼 Stainless steel	18-8 ステンレス鋼 18-8 stainless steel	SUS304TP	WP304	A182-F304	A312-TP304	A240-Type304
	高温用18-8 ステンレス鋼 18-8 stainless steel for high temperature	SUS304HTP	WP304H	A182-F304H	A312-TP304H	A240-Type304H
	低炭素18-8 ステンレス鋼 Low carbon 18-8 stainless steel	SUS304LTP	WP304L	A182-F304L	A312-TP304L	A240-Type304L
	22-12 ステンレス鋼 22-12 stainless steel	SUS309STP	WP309	—	A312-TP309	A240-Type309S
	22-20 ステンレス鋼 22-20 stainless steel	SUS310STP	WP310	A182-F310	A312-TP310	A240-Type310S
	18-8-(Nb+Ta) ステンレス鋼 18-8-(Nb+Ta) stainless steel	SUS347TP	WP347	A182-F347	A312-TP347	A240-Type347
	18-8-Mo ステンレス鋼 18-8-Mo stainless steel	SUS316TP	WP316	A182-F316	A312-TP316	A240-Type316
	高温用18-8-Mo ステンレス鋼 18-8-Mo stainless steel for high temperature	SUS316HTP	WP316H	A182-F316H	A312-TP316H	A240-Type316H
	低炭素18-8-Mo ステンレス鋼 Low carbon 18-8-Mo stainless steel	SUS316LTP	WP316L	A182-F316L	A312-TP316L	A240-Type316L
	18-8-Ti ステンレス鋼 18-8-Ti stainless steel	SUS321TP	WP321	A182-F321	A312-TP321	A240-Type321
	高温用18-8-Ti ステンレス鋼 18-8-Ti stainless steel for high temperature	SUS321HTP	WP321H	A182-F321H	A312-TP321H	A240-Type321H
	高温用18-8-(Nb+Ta) ステンレス鋼 18-8-(Nb+Ta) stainless steel for high temperature	SUS347HTP	WP347H	A182-F347H	A312-TP347H	A240-Type347H
	25-5 Mo ステンレス鋼 25-5 Mo Stainless steel	SUS329J1TP	—	—	A268-TP329	—

基準山形

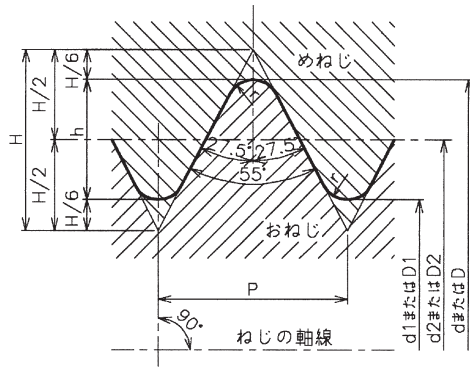

$$P = 25.4/n$$

$$H = 0.960491P$$

$$h = 0.640327P$$

$$r = 0.137329P$$

$$d2 = d - h \quad D2 = d2$$

$$d1 = d - 2h \quad D1 = d1$$

寸法許容差

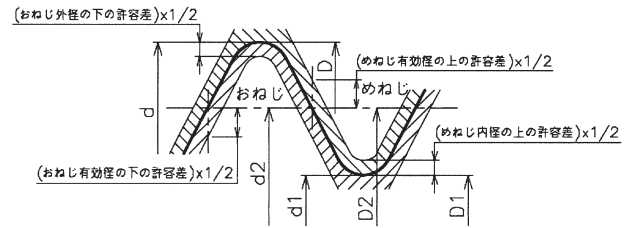

基準寸法

単位：mm

ねじの呼び	ねじ山数 (25.4mmにつき) n	ピッチ p (参考)	ねじ山の高さ h	山の山頂 及び 谷の丸み r	おねじ		
					外径 d	有効径 d2	谷の径 d1
					谷の径 D	有効径 D2	内径 D1
G½	28	0.9071	0.581	0.12	9.728	9.147	8.566
G¼	19	1.3368	0.856	0.18	13.157	12.301	11.445
G⅜	19	1.3368	0.856	0.18	16.662	15.806	14.950
G½	14	1.8143	1.162	0.25	20.955	19.793	18.631
G¾	14	1.8143	1.162	0.25	26.441	25.279	24.117
G1	11	2.3091	1.479	0.32	33.249	31.770	30.291
G1¼	11	2.3091	1.479	0.32	41.910	40.431	38.952
G1½	11	2.3091	1.479	0.32	47.803	46.324	44.845
G2	11	2.3091	1.479	0.32	59.614	58.135	56.656
G2½	11	2.3091	1.479	0.32	75.184	73.705	72.226
G3	11	2.3091	1.479	0.32	87.884	86.405	84.926

寸法許容差

単位：μm

ねじの呼び	ねじ山数 [25.4mmにつき] n	おねじ						めねじ						
		外径 d		有効径 d2		谷の径 d1		谷の径 D		有効径 D2		内径 D1		
		上の許容差	下の許容差	上の許容差	下の許容差		上の許容差	下の許容差	下の許容差	上の許容差	下の許容差	上の許容差		
G½	28	0	-214	0	-107	-214	0		0		0	+107	0	+282
G¼	19	0	-250	0	-125	-250	0		0		0	+125	0	+445
G⅜	19	0	-250	0	-125	-250	0		0		0	+125	0	+445
G½	14	0	-284	0	-142	-284	0		0		0	+142	0	+541
G¾	14	0	-284	0	-142	-284	0	規定しない	0	規定しない	0	+142	0	+541
G1	11	0	-360	0	-180	-360	0		0		0	+180	0	+640
G1¼	11	0	-360	0	-180	-360	0		0		0	+180	0	+640
G1½	11	0	-360	0	-180	-360	0		0		0	+180	0	+640
G2	11	0	-360	0	-180	-360	0		0		0	+180	0	+640
G2½	11	0	-434	0	-217	-434	0		0		0	+217	0	+640
G3	11	0	-434	0	-217	-434	0		0		0	+217	0	+640

テーパおねじ及び
テーパめねじに対して
適用する基準山形

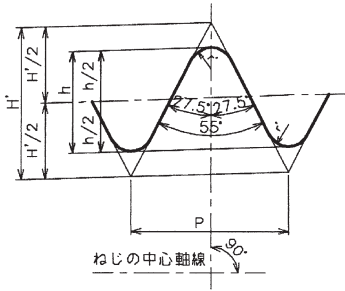

$P=25.4/n$
 $H=0.960237P$
 $h=0.640327P$
 $r=0.137278P$

平行めねじに対して
適用する基準山形

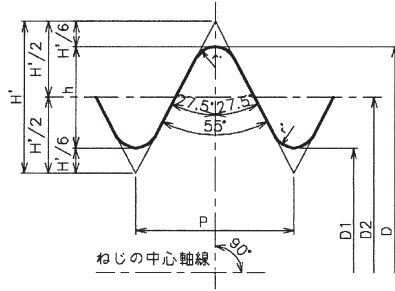

$P=25.4/n$
 $H'=0.960491P$
 $h=0.640327P$
 $r'=0.137329P$

テーパおねじと
テーパめねじまたは
平行めねじとのハメアイ

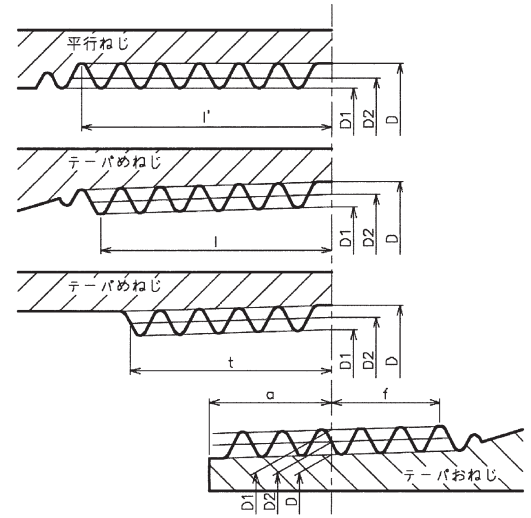

寸法許容差

単位：mm

ねじの呼び	ねじ山				基準径			基準径の位置			平行めねじのD, D2及びD1の許容差	有効ねじ部の長さ(最小)				配管用炭素鋼鋼管の寸法(参考)		
	ねじ山数 25.4mmにつき n	ピッチ p (参考)	山の 高さ h	丸み r 又は r'	おねじ			おねじ		めねじ		基準径の位置から大径側に向かってf	不完全ねじ部がある場合		不完全ねじ部がない場合			
					外径 d	有効径 d2	谷の径 d1	管端から	管端部	テーパめねじ			平行めねじ	テーパめねじ, 平行めねじ				
															谷の径 D			有効径 D2
G $\frac{1}{8}$	28	0.9071	0.581	0.12	9.728	9.147	8.566	3.97	± 0.91	± 1.13	± 0.071	2.5	6.2	7.4	4.4	10.5	2.0	
G $\frac{1}{4}$	19	1.3368	0.856	0.18	13.157	12.301	11.455	6.01	± 1.34	± 1.67	± 0.104	3.7	9.4	11.0	6.7	13.8	2.3	
G $\frac{3}{8}$	19	1.3368	0.856	0.18	16.662	15.806	14.950	6.35	± 1.34	± 1.67	± 0.104	3.7	9.7	11.4	7.0	17.3	2.3	
G $\frac{1}{2}$	14	1.8143	1.162	0.25	20.955	19.793	18.631	8.16	± 1.81	± 2.27	± 0.142	5.0	12.7	15.0	9.1	21.7	2.8	
G $\frac{3}{4}$	14	1.8143	1.162	0.25	26.441	25.279	24.117	9.53	± 1.81	± 2.27	± 0.142	5.0	14.1	16.3	10.2	27.2	2.8	
G1	11	2.3031	1.479	0.32	33.249	31.770	30.291	10.39	± 2.31	± 2.89	± 0.181	6.4	16.2	19.0	11.5	34.0	3.2	
G1 $\frac{1}{4}$	11	2.3091	1.479	0.32	41.910	40.431	38.952	12.70	± 2.31	± 2.89	± 0.181	6.4	18.5	21.4	13.4	42.7	3.5	
G1 $\frac{1}{2}$	11	2.3091	1.479	0.32	47.803	46.324	44.845	12.70	± 2.31	± 2.89	± 0.181	6.4	18.5	21.4	13.4	48.6	3.5	
G2	11	2.3090	1.479	0.32	59.614	58.135	56.656	15.88	± 2.31	± 2.89	± 0.181	7.5	22.8	25.7	16.9	60.5	3.8	
G2 $\frac{1}{2}$	11	2.3090	1.479	0.32	75.184	73.705	72.226	17.46	± 3.46	± 3.46	± 0.216	9.2	26.7	30.2	18.6	76.3	4.2	
G3	11	2.3691	1.479	0.32	87.884	86.405	84.926	20.64	± 3.46	± 3.46	± 0.216	9.2	29.9	33.3	21.1	89.1	4.2	

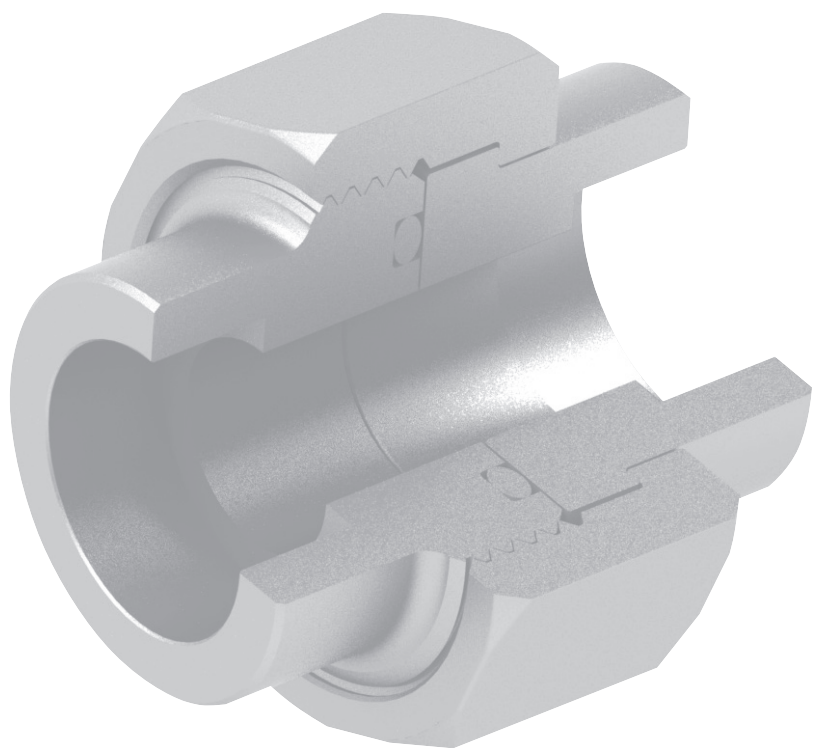



注意

継手、バルブ、関連するアクセサリーの不適切な選択又は取扱いは、人体やシステムに障害・損傷を与える恐れがあります。システム設計者及びユーザーの責任と権限による判断のもとに、使用されるシステムとの適合性や使用条件を考慮のうえ、継手、バルブ、関連するアクセサリーを選定し、適切な取り付け、操作及びメンテナンスを行って下さい。ご使用にあたり、取扱説明書をお読みいただき内容をよくご理解下さい。取扱説明書がお手元に無い場合及び不明な点はもよりの事業部営業部にお問い合わせ下さい。



WARNING

If you don't select and handle fittings, valves and related accessories in an adequate manner, it may damage human beings and applicable systems. Within the responsibility and authorization of users and piping designers, fittings, valves and related accessories shall be adequately selected, assembled, used and maintained based on the applicable conditions and product conformity to the system to be applied. Please read carefully our operation manual and feel free to contact with Ihara if you have any question or request.

製品保証期間について

1.保証期間

当社製品の保証期間は、使用開始から1年以内、もしくは納入後1.5年以内、いずれか早期に到達する期間と致します。ただし、製品が特殊仕様である場合や当社の設計仕様を逸脱した状態で使用された場合は、この限りではありません。また、製品には耐久回数、交換部品などを定めているものがありますので、最寄の当社営業所にて御確認下さい。

2.保証範囲

保証期間中において当社の責による故障や損傷が明らかになった場合は、代替品又は必要な交換品を無償で提供致します。なお、ここでの保証は、当社製品単体の保証を意味するもので、当社製品の故障や損傷により誘発される損害は、保証の対象範囲から除外させていただきます。

Product Warranty

1.Warranty Period

The warranty period of our products is one (1) year from putting into service or one and half (1.5) years after delivery whichever comes earlier. However, the products of special specification and/or the cases used under deviating from the specification shall be exempted. Please inquire us for the products that specify the service life or replacing parts.

2.Scope of Warranty

Any failure and damage under maker's responsibility will be found during the warranty period, the substitute and/or replacement parts shall be provided free of charge. The warranty shall not be extended to a claim for the liquidated damages.



ISO9001, ISO14001 認証事業所

ISO9001, ISO14001 Certified Office

イハラサイエンス株式会社

IHARA SCIENCE CORPORATION

- ・東日本営業所 / 〒108-0074 東京都港区高輪3丁目11番3号 イハラ高輪ビル
TEL 03-6721-6981 (代) FAX 03-6721-6991
- ・中部営業所 / 〒460-0012 名古屋市中区千代田3丁目14番19号 (千代田ツカサビル)
TEL 052-323-2627 (代) FAX 052-323-2630
- ・西日本営業所 / 〒530-0044 大阪市北区東天満2丁目6番5号 (I・S南森町ビル)
TEL 06-6358-9255 (代) FAX 06-6358-9260

海外販売拠点
台湾：台中
中国：南通
韓国：ソウル
米国：カリフォルニア

■ URL: <http://www.ihara-sc.co.jp>

■ 本カタログの記載内容は、商品の改良等のため予告なく変更することがありますので、予めご了承下さい

■ The contents of this catalog are subject to change without notice due to improvement of products or other reasons.